

F3Ci IED and Mine Detector



SERVICE MANUAL

Version 1:
Part No:



Contents

1.	Introduction	3
2.	Mechanical & Functional Testing	4
3.	Disassembly & Reassembly Procedures.....	12
3.1	Opening the Detector Body.....	13
3.2	Closing the Detector Body.....	16
3.3	Main Printed Circuit Board (PCB).....	22
3.3.1	Removing the Main PCB	23
3.3.2	Installing the Main PCB.....	26
3.4	Coil	30
3.4.1	Skid Plate Replacement	31
3.4.2	Removing the Coil	31
3.4.3	Coil Pivot.....	33
3.4.4	Removing Coil Pivot.....	34
3.4.5	Fitting the Coil Pivot	36
3.4.6	Fitting the Coil	38
3.5	Shafts.....	41
3.5.1	Replacing a Camlock.....	42
3.5.2	Removing the Shafts.....	42
3.5.3	Fitting the Shafts	44
3.6	Handle	45
3.6.1	Removing the Handle	46
3.6.2	Fitting the Handle.....	47
3.7	Armrest.....	48
3.7.1	Replacing the Armrest.....	48
3.8	Battery Compartment	49
3.8.1	Battery Lid Replacement.....	50
3.8.2	Battery Compartment Replacement	50
3.9	Detector Body.....	51
3.9.1	Control Switches Replacement	51
3.9.2	Speaker Replacement.....	54
3.9.3	Wiring Loom Earset Replacement.....	55
3.9.4	Wiring Loom Handle Socket Replacement	56
3.9.5	Detector Body Parts	57
4.	Fault Finding Procedures.....	60
4.1	Introduction.....	60
4.2	Trouble Shooting Table	60

1. Introduction

a. Servicing the F3Ci includes fault finding, repair and maintenance and is designed to be simple and fast thereby reducing the amount of time a detector is unusable. Repair and maintenance is based on line replaceable units which can be fitted to a detector without the need for adjustment or calibration. Additionally, serviceable line replaceable units can be exchanged between detectors as required.

b. Line replaceable units are components or sub-assemblies of the F3Ci that can be purchased from Minelab for the purpose of repairing the F3Ci. Line replaceable units include the following:

3004-0135	Coil Kit F3Ci	
3004-0130	Coil Pivot Kit F3Ci	*
3004-0131	Shaft Kit F3Ci	*
3004-0047	Camlock kit	*
3004-0048	Armrest Kit with Slide	*
3004-0049	Armrest Kit	*
3004-0132	Handle Kit	
3004-0051	Battery Compartment Kit	*
3004-0052	Battery Lid Kit	*
3004-0133	Main PCB Kit F3Ci	
3004-0054	Switches Kit	*
3004-0056	Wiring Loom Handle Socket Kit	*
3004-0057	Speaker Kit	*
3004-0058	Wiring Loom Earset Kit	*

* LRUs that are common to the Minelab F3 COMPACT detector

c. Servicing the F3Ci can be conducted in the field (under clean dry conditions) or at local service centres. No special tools are required, but it is recommended that the F3Ci Service Tool Kit be used.

d. Servicing the F3Ci is restricted to the exchange of line replaceable units following the identification of a faulty sub-assembly. Servicing DOES NOT include any repairs to printed circuit boards as this is only conducted at a Minelab facility.

e. This manual should be read in conjunction with the F3Ci Operations Manual. Additionally, from time to time, Minelab will issue Technical Service Notes which serve to supplement the information contained in this manual.

f. Any questions regarding this manual or any repair procedure can be directed to Minelab at Countermine@minelab.com.au

2. Mechanical & Functional Testing

a. The detector set should be regularly checked to ensure all parts and accessories are present and in good working order. The F3Ci is supplied as a mine detecting set comprising:

F3Ci Detector	4901-0144 Operations Manual F3Ci
5305-0111 Hard Case (optional)	4903-0048 Field Guide
3001-0064 Soft Carry Bag	8701-0022 Test Piece
4523-0027 Earset Speaker ON	Four C-Cell Batteries
OR	(Alkaline or Rechargeable)
4523-0025 Earset Speaker OFF	

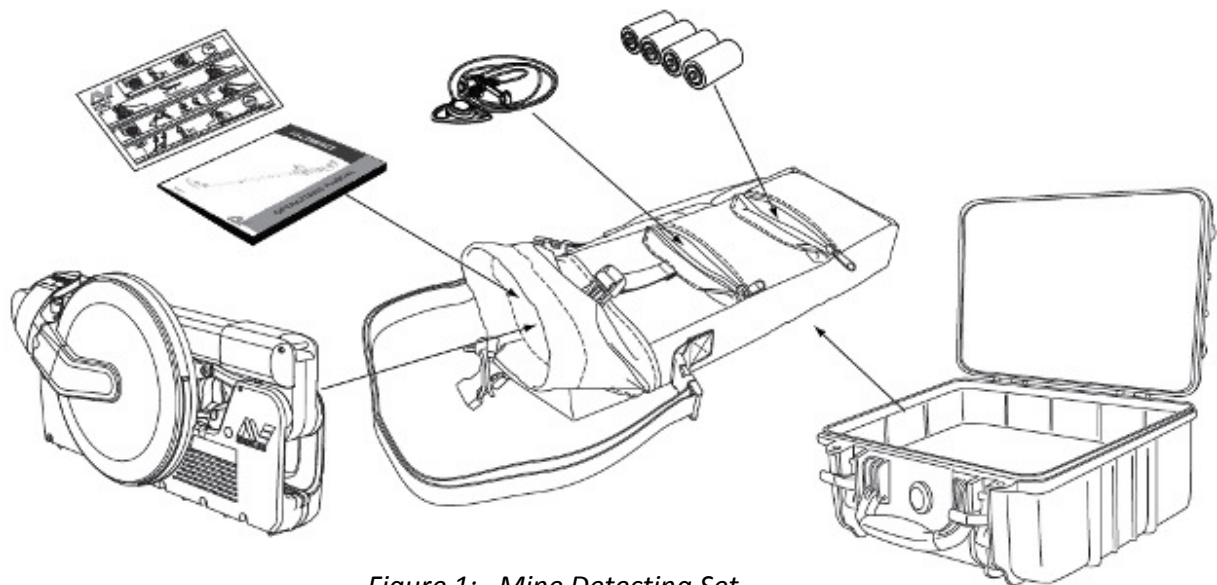

Figure 1: Mine Detecting Set

b. Whenever a detector is returned for servicing, mechanical and functional tests must be completed to confirm and/or identify any faults.

c. At the completion of any maintenance or repair procedure, **ALL** mechanical and functional tests must be completed to confirm the detector is working correctly and no faults remain.

d. If a detector fails **ANY** of the mechanical or functional tests it must not be used in demining operations.

2.1 Mechanical Testing

a. Confirm all parts and accessories are present and in good working order. Unpack the detector and prepare for use. Figure 2 identifies the major components of the F3Ci. Mechanical testing and inspection includes checking:

- The detector for any obvious signs of damage,
- Coil movement is smooth in both axes and holds its position without drooping,
- The skid plate is attached and has no holes or cracks,
- Shafts extend and retract smoothly and the camlocks hold the shafts firmly in location,
- The shaft hinge moves freely when the handle is stowed down and locks into extended position when the handle is deployed up,
- The battery lid opens and locks, the battery lid tether is in good condition, and the battery lid O-ring is clean and in good condition,
- The handle slides up and down freely locking into position,
- The armrest extends and retracts smoothly,
- The armrest strap is in good condition,
- The earset dust caps are in good condition, and
- Sensitivity and On/Off knobs do not turn unless lifted and rotated and then spring back into the locked position when released.

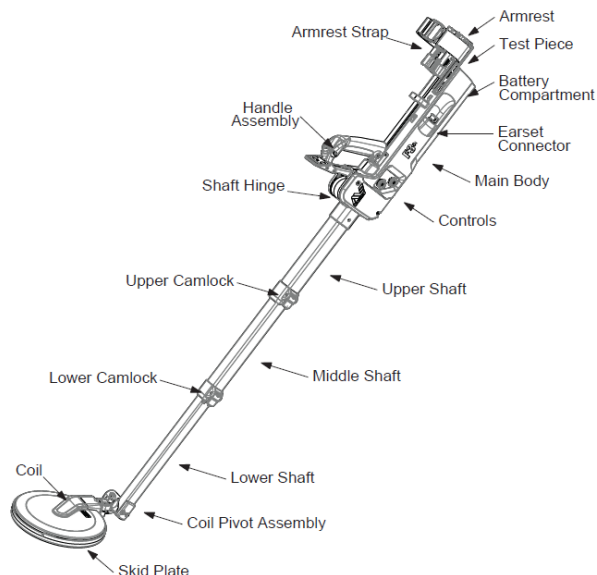

Figure 2: F3Ci Major Components

b. The detector must pass all mechanical tests and checks to be considered acceptable for operational use.

2.2 Functional Testing

a. Functional testing is used to confirm the serviceability of an F3Ci before it is returned to the field for use and whenever doubt exists about its serviceability. The F3Ci must pass all tests to be considered serviceable and ready for use. Whenever a line replaceable unit is replaced or a repair is conducted, all functional testing must be completed.

b. Functional testing requires a ground balance test piece. The ground balance test piece simulates mineralised ground which results in a detection tone from the detector. A mineralised “hot” rock or adequate amounts of local mineralised soil is suitable. Alternatively, a ceramic floor tile or clay roof tile may be suitable for use as a ground balance test piece.

c. **The Switch on Test.** The switch on test checks that power is correctly supplied to the F3Ci and internal diagnostics discover no system fault. The test is conducted as follows:

- Prepare the detector for use.
- Hold the coil at least 60cm (24in) away from the ground and any metal objects.
- Ensure the sensitivity knob is set to the default position 4.
- Switch on.
- Ensure that a rising tone is heard followed by two beeps (indicating the F3Ci is set to sensitivity position 4). The F3Ci will now begin detecting metal, if no metal targets are detected a heartbeat tone will commence.

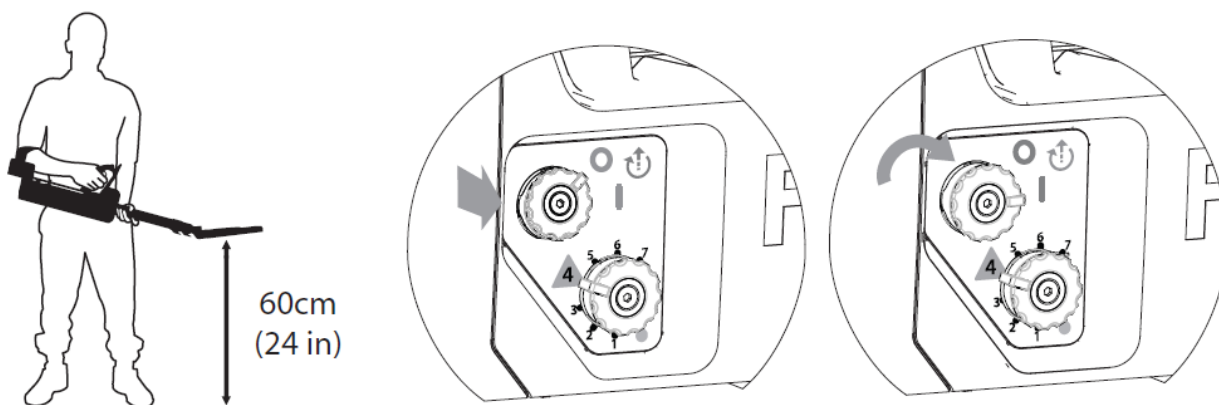

Figure 3: Switch On

d. **Noise Cancel Test.** The noise cancel test ensures the F3Ci successfully completes the noise cancel procedure required whenever local electrical interference is present. The test is conducted as follows:

- Hold the coil stationary and at least 60cm (24 in) off the ground and away from any metal objects during the test.
- Press and **immediately release** the Noise Cancel button. (Figure 4)

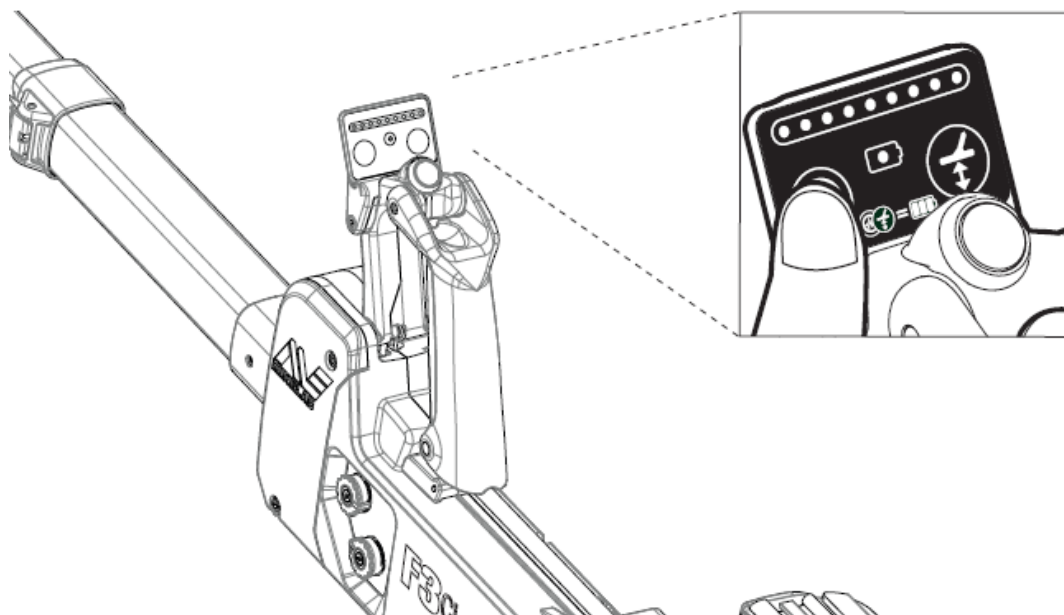

Figure 4: Noise Cancel

Note

The coil should not be moved nor should metallic objects be brought near the coil during this procedure.

- The noise cancelling procedure will commence with a single beep followed by 20 seconds of sharp triple beeps and finish with a four beep sequence.
- During the 20 seconds the F3Ci scans the environment searching for the source of any electrical interference. Once detected, the detector will automatically select a different operating frequency to eliminate or reduce the interference.

e. Ground Balance Test. This test confirms the F3Ci is capable of ground balancing against mineralised ground. In doing so, it confirms the correct operation of the ground balance button, coil and associated circuitry. The ground balance test can be conducted over local soil if sufficiently mineralised or a ground balance test piece can be used. A mineralised “hot” rock or a ceramic floor tile or clay roof tile may be suitable for use as a ground balance test piece. The test is conducted as follows:

- Ensure hands and arms are free of metallic objects (watches, rings etc) and that no other metallic objects are near the coil.
- Keep the detector stationary and away from ground or metal objects, press and release the ground balance button. Continue to hold the detector stationary until the ground balance OK tone is heard.

Note

This action will cause the F3Ci to delete the previously stored ground balance condition. Unless this is done the detector will remember its last ground balance condition regardless of the unit being switched off or the batteries removed.

- Move the ground balance test piece from approximately 15cm (6in) above the coil towards the centre of the coil and confirm that a detection tone occurs. This confirms that the detector is detecting the mineralised content of the ground balance test piece.
- Press down and release the ground balance button whilst moving the ground balance test piece from approximately 15cm (6in) above the coil towards the centre of the coil (and touching the coil). Then, move the ground balance test piece away from the centre of the coil to a distance of 15cm (6in).
- Repeat this process until the 'Ground Balance OK' tone consisting of a short high-pitched double beep occurs. This tone confirms the ground balance procedure has been completed correctly.
- Confirm the ground balance is correct by moving the ground balance test piece from approximately 15cm (6in) above the coil towards the centre of the coil. If there is no detection tone from the ground balance test piece the ground balance procedure is functional.

Note

Where the ground balance test is conducted using local soil Figure 5 illustrates the procedure to be followed.

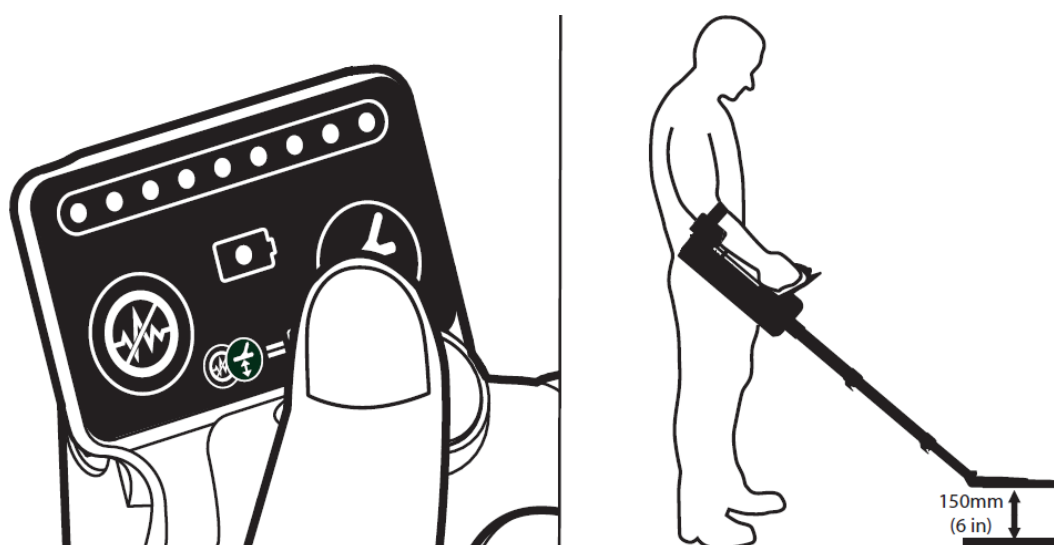

Figure 5: Ground Balance

f. Earset Test. This test confirms the earset is operating correctly and is conducted as follows:

- Plug the earset into the detector as shown in Figure 6.
- Switch on the detector and confirm the audio tones are audible using the earset.
- If an earset speaker On (4523-0027) is being tested check that the tones can also be heard from the detector loudspeaker.
- If an earset speaker Off (4523-0025), identified by green band on the earset cable near the plug, is being tested check that tones can only be heard in the earset and not the detector loudspeaker.

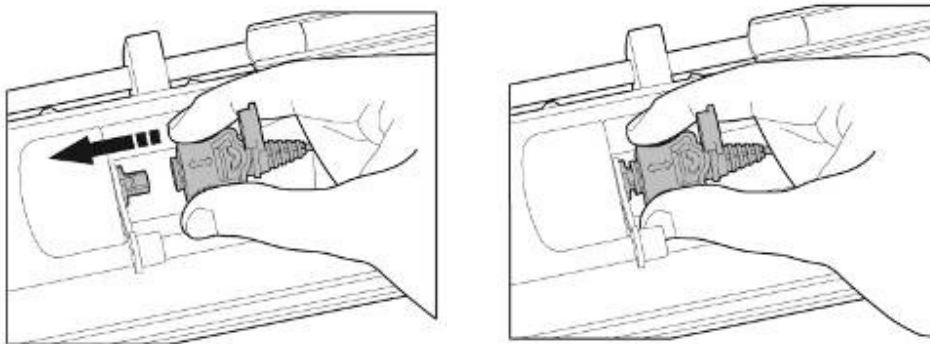

Figure 6: Connecting the Earset

g. LED Test. This test confirms the visual indicator (lights) can be enabled and operate correctly. To conduct the test:

- Turn on the detector.
- Pass the coil over a metal object and check no LEDs are turned on, by default the LEDs are off.
- Turn on the LEDs, press and **Hold** the Yellow mode select button and then press and **Release** the ground balance button, check that a single LED is turned on when no metal objects are near the coil.
- Pass the coil over a metal object and check that an increasing number of LEDs illuminate as the detection tone increases.
- The LEDs are toggled on and off by pressing and **Holding** the yellow mode select button and then pressing and **Releasing** the ground balance button.

h. Vibration Test. This test confirms that the vibration feature can be enabled and vibrates the detector when there is a detection tone. The test is conducted as follows:

- Turn on the detector.
- Pass the coil over a metal target and confirm that no vibrations are felt, by default the vibration feature is off.

-
- Turn on the vibration feature, press and **Hold** the yellow mode select button and then press and **Release** the noise cancel button.
 - Pass the coil over a metal target and confirm that the vibrations can be felt.
 - The vibration feature is toggled on and off by pressing and **Holding** the yellow mode select button and then pressing and **Releasing** the noise cancel button.
- i. **Battery Level Test.** This test ensures that battery level indicator is operational and provides an indication of battery capacity, the battery level test is conducted as follows:
- Turn the detector on.
 - Press and **Hold** the noise cancel button then press and **Release** the ground balance button.
 - Confirm a series of LEDs illuminate indicating the level of battery power remaining.
 - After three seconds the battery level indicator will extinguish and normal operation will resume.
- j. **Sensitivity Control Test.** This test confirms the sensitivity control allows the operator to make adjustments to the sensitivity of the F3Ci. The test is conducted as follows:
- Set the sensitivity to the default position 4.
 - Turn on the detector.
 - Conduct the test piece test (refer to Section 2.2.k). Check that a faint but clear audio tone is heard and that more than one LED illuminates.
 - Decrease the sensitivity of the F3Ci by rotating the sensitivity knob counter clockwise to position 2. A single low pitched beep will be heard to prompt the operator that the sensitivity is being decreased.
 - Conduct the test piece test again and ensure no audio or LED response occurs.
 - Move the sensitivity knob to position 4 and confirm a double beep occurs. This prompts the operator that default sensitivity (position 4) has been selected.
 - Rotate the sensitivity knob clockwise to position 6 and confirm that a single high pitched beep is heard.
 - Conduct the test piece test and confirm that a louder audio response and an increased number of LEDs are illuminated when compared to the previous position 4 or 2.
- k. **Test Piece Test.** This test should be conducted in an environment that is free from electrical interference and an earset must be connected. The detector must pass the test piece test to be considered fit for use. The test is conducted as follows:
- Ensure hands and arms are free of metallic objects (watches, rings etc) and that no other metallic objects are near the coil.
 - Set the sensitivity control to the default position 4 then switch on the F3Ci.

- Hold the test piece above the middle of the coil with the rounded end (containing metallic target) **Away** from the coil.
- Move the test piece towards the centre of the coil until it lightly touches the coil then move it away in the same direction.

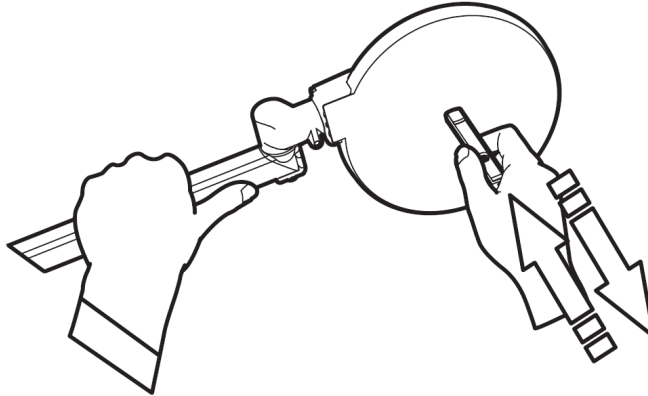

Figure 7: Test Piece Procedure

- Confirm a faint but clear response is heard.

Note

The test piece test can only be conducted with the sensitivity control in the green position (Sensitivity No 4). When the sensitivity control is not set to the green position 4 it is the responsibility of the user to provide an appropriate target with which to confirm the sensitivity of the detector satisfies operational requirements.

3. Disassembly & Reassembly Procedures

a. This section describes the procedures required to exchange line replaceable units. Whenever a unit is replaced, mechanical and functional testing as described in Section [2 - Mechanical & Functional Testing](#) must be completed.

b. It is recommended that the 3004-0055 F3Ci service tool kit be used to conduct disassembly and reassembly procedures. The tool kit contains the following:

- Pull-through for coil cable
- Flat blade screwdriver
- 3mm hex key driver
- 2.5mm hex key driver
- 2mm hex key driver
- T20 Torx driver
- 18mm spanner
- 13mm spanner
- 10mm spanner
- 3mm pin punch
- Screwdriver Pozidrive No 1
- Screwdriver Pozidrive No 2
- Tube Spanner 7/8
- Silicone grease

3.1 Opening the Detector Body

- a. In order to conduct repairs and replace many of the parts of this detector, the first step will often be to open the detector body. Many sections of this manual will refer back to this section.
- b. The following procedure outlines the steps involved in opening the detector body:
- Prepare a clean well lit workspace.
 - Turn the detector off and remove the batteries.
 - Remove the four screws from the top of the armrest and remove the armrest.

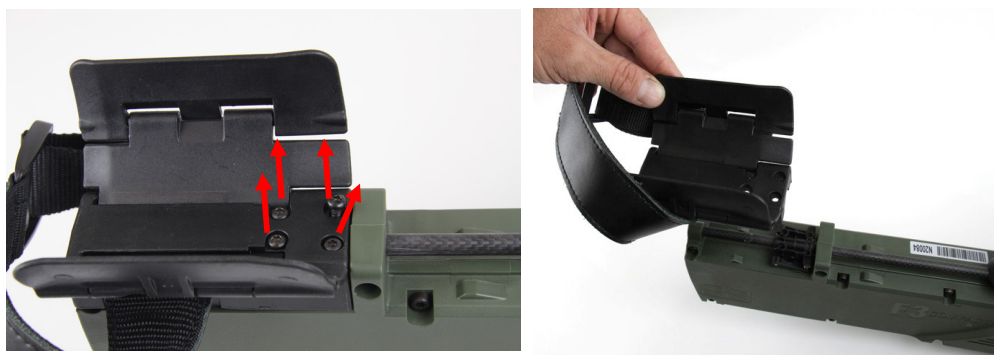

Figure 8: Removing the Armrest

- Place the detector on its right side with the ON/OFF knob uppermost and remove the two screws (45mm) that secure the hinge cover. Figure 9.
- Remove the hinge cover.



Figure 9: Removing Hinge Cover

- Unscrew and disconnect the coil plug.
- Remove the two screws (35mm) from the shaft hinge. Figure 10.



Figure 10: Disconnecting Coil Plug and Removing Screws

- Turn the detector over onto its left side with speaker grill uppermost.
- Using the 3mm hex key driver, remove all eight screws from the detector body.

Note

There are four 35mm long screws and four 20mm long screws.



Figure 11: Removing Eight Screws (Allen Key)

- Using a T20 Torx (star) driver unscrew all four screws (three 35mm and one 20mm) from the right side of the detector.

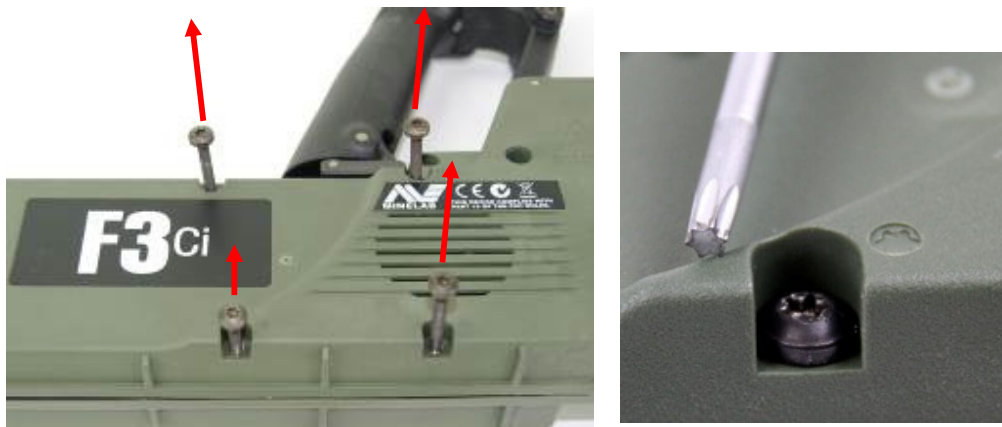

Figure 12: Removing Four Torx Screws

- Using fingers gently separate the left and right body halves. The battery end of the detector will come away easily. The shaft end is held by two locating pins and will require more force to separate.
- Gently lift the right side off the left body half taking care not to pull or stretch the speaker cable and connector. Figure 13.
- Locate the speaker connector on the PCB and disconnect the speaker from the PCB. Remove the right half of the detector body.

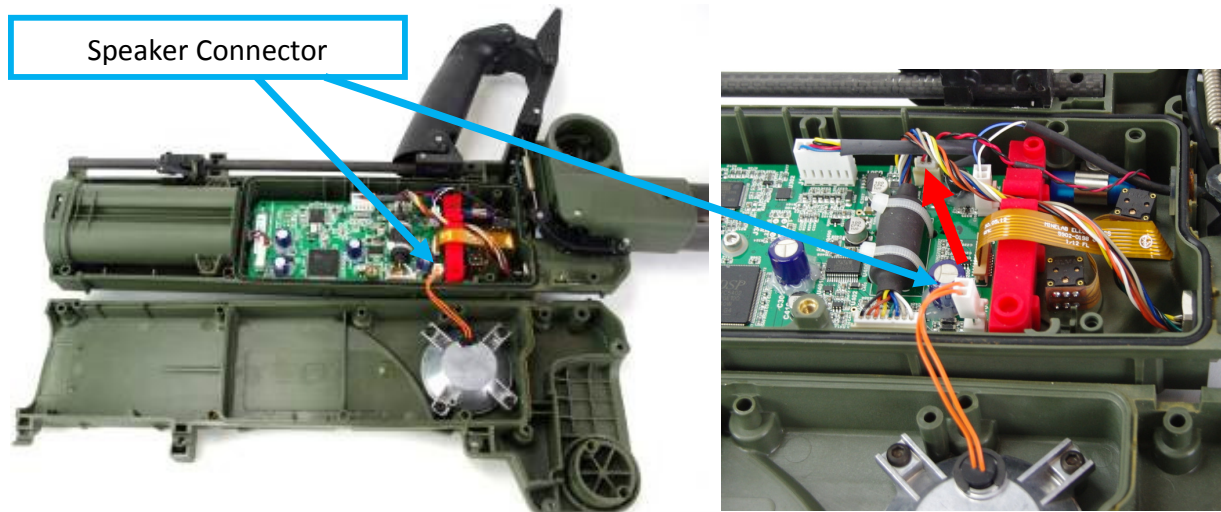

Figure 13: Disconnecting Speaker Connector

- Remove the upper shaft from the detector body taking care not to snag and damage the coil cable and plug.

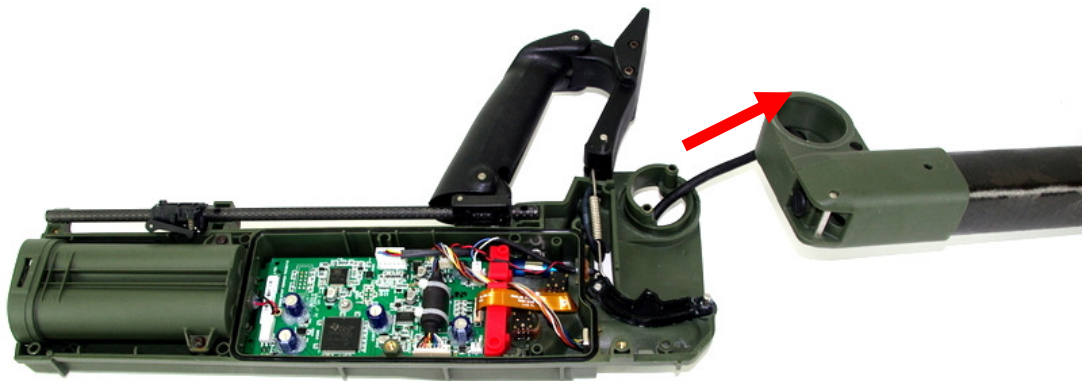

Figure 14: Removing Shafts

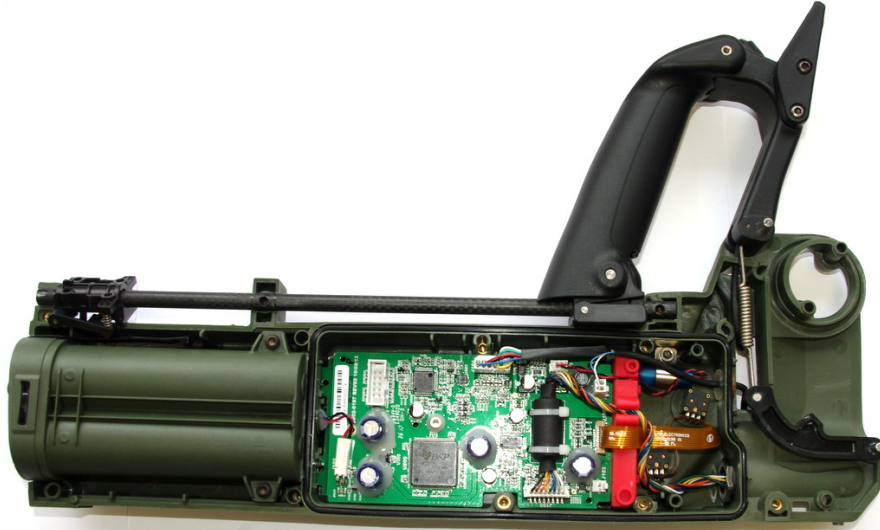

Figure 15: Open Detector Body

- c. The body of the detector is now opened revealing the internal components which can now be replaced as required.

3.2 Closing the Detector Body

- a. The following procedure outlines the steps involved in closing and resealing the detector body:
- Ensure all parts are present, in good working order and lay the detector body on its left side.
 - Thread the coil cable through the detector hinge and position the upper shaft into the detector body.

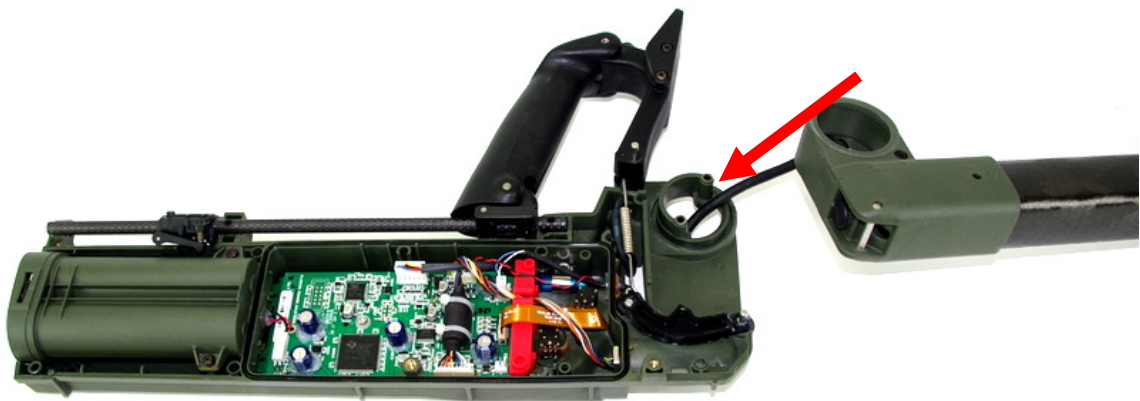

Figure 16: Threading Coil Cable and Attaching Shafts

- Carefully turn the detector body over so that it is on its right side. Check the coil connector nut is tight.

- Attach the coil connector to the socket and tighten the coil connector as tight as possible with fingers. Figure 17.
- Fit the coil cable into the cable router and check that the loop of coil cable within the shaft hinge is positioned so that it will not be trapped when the detector body is closed. Refer to Figure 20.

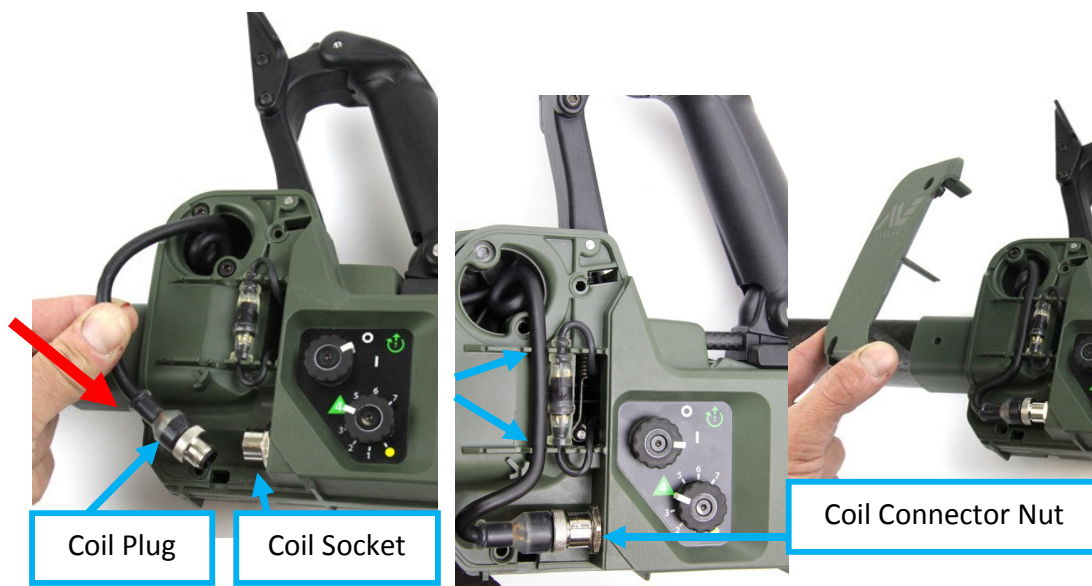

Figure 17: Connecting Coil Cable and Removing Hinge Cover

- Fit the hinge cover but **Do Not** fit the two hinge cover screws. Turn the detector body over so it is on its left side.
- Check the detector handle is correctly positioned on the detector as well as the armrest slide. The rod detector slide must be positioned through the handle and armrest slide. The holes in the rod detector slide must align with the holes in the detector body.
- Check that the latch hinge and spring latch hinge are correctly positioned into the left side of the detector body with the latch connected to the spring.



Figure 18: Latch Hinge and Spring Latch Hinge

Note

The hinge cover holds the latch hinge and spring latch hinge in place. When the hinge cover is removed the spring may unintentionally disconnect from the latch.

- Ensure the battery lid is closed.
- Connect the speaker cable to the connector on the main PCB. Check all other connectors and cables are connected.

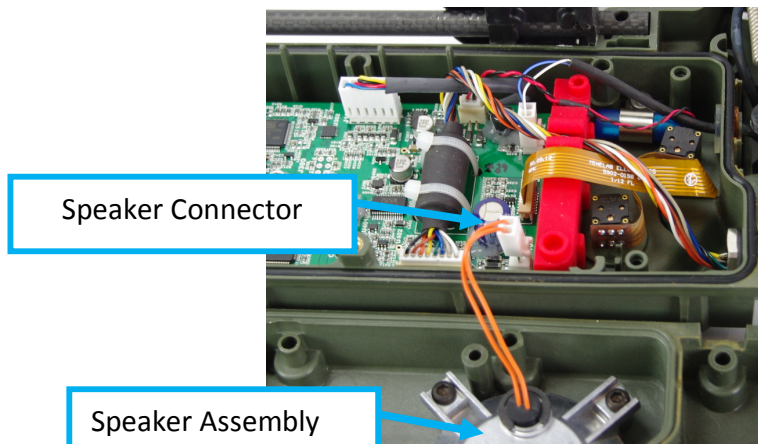

Figure 19: Connecting Speaker

- Check the O-ring in the detector body is clean, lightly greased and correctly positioned.
- Check all internal cables and wires are correctly positioned and will not be trapped.
- The coil cable must be located within the shaft hinge so that it is not trapped or damaged when the halves of the detector body are fitted together. In particular, the coil cable must not be positioned above the hinge screw bosses.

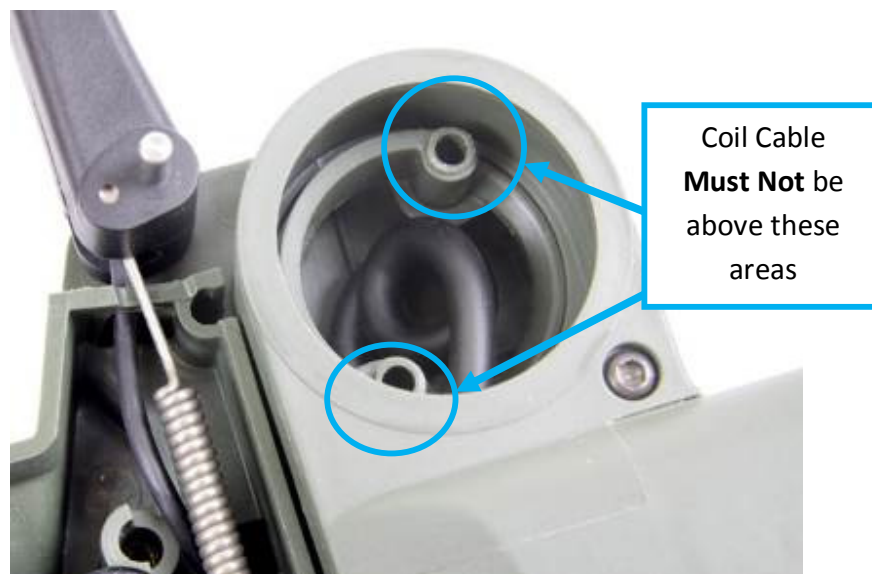

Figure 20: Coil Cable Position in Shaft Hinge

- Ease the two halves of the detector together. Align the detector body right side with the locating pins either side of the shaft hinge.
- Check the latch hinge and spring latch hinge are in place and connected.
- Once the two sides of the detector are together check the handle, shafts and armrest slide are correctly fitted. Carefully hold the detector together whilst turning the detector over onto its right side with the hinge cover facing up.
- Remove the hinge cover to check the coil cable is not trapped within the shaft hinge. Refer to figure 20.
- Check the latch hinge and spring latch hinge are still connected as shown in Figure 18.
- Refit the hinge cover.
- Insert the four screws (two 20mm and two 35mm) as indicated in Figure 21 but do not fully tighten at this point.



Figure 21: Fitting Four Screws

- With the detector loosely held together check the handle slides up and down correctly. Check the armrest slide also moves freely along the rod detector slide.
- Check the battery lid moves in and out and ensure the battery lid is closed.
- Starting with the two long (35mm) screws fit the four remaining screws into the right side of the detector as indicated by figure 22.
- Tighten all eight screws.



Figure 22: Fitting Four Screws

- Identify the four Torx screws (star) and check they all have O-rings fitted. Insert the four Torx screws into the right side of the detector. The Torx screw positions have a Torx symbol next to their screw holes. Insert the three long screws first.

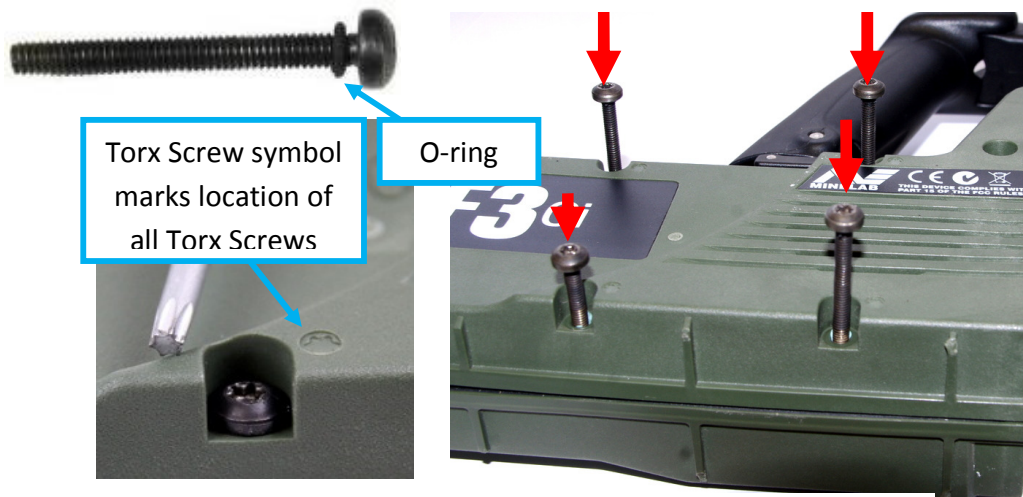

Figure 23: Fitting Torx Screws.

- Check the detector assembly and test all moving parts.
- Place the detector on its right side. Remove the hinge cover then insert and tighten the two screws (35mm) into the shaft hinge.



Figure 24: Fitting Screws into the Shaft Hinge

Note

Do not move the detector with the hinge cover removed as this may result in the spring latch hinge and the latch hinge becoming disengaged.

- Confirm coil connector is tight and check the coil cable and the wiring loom are located into the cable router.
- Check the latch and spring are connected as shown in Figure 25. If the latch and spring have become disconnected they must be reconnected. It is possible to reattach the eyelet of the spring to the pin of the latch hinge through the opening under the hinge cover. Alternately the detector body can be opened to reattach the spring to the latch.

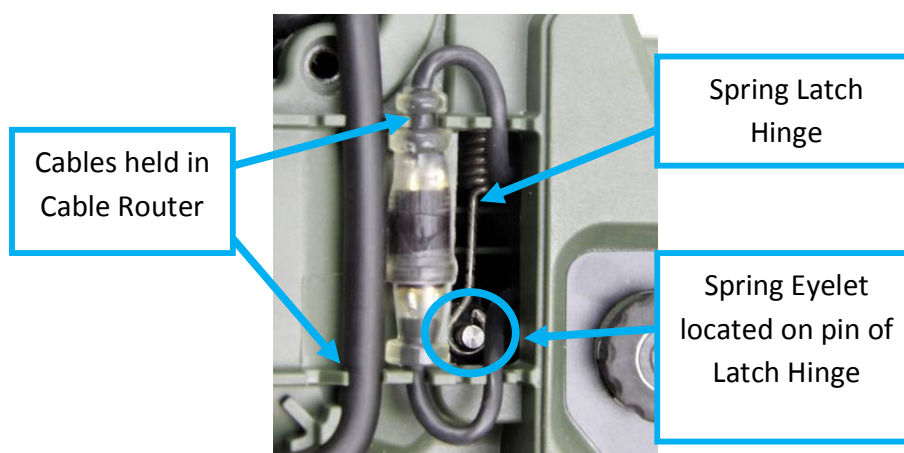

Figure 25: Underneath Hinge Cover

- Fit the hinge cover and make sure the protrusion on the underside of the hinge cover engages into the slot on the detector body near the hinge. Fit the two screws (45mm) into the hinge cover and tighten.

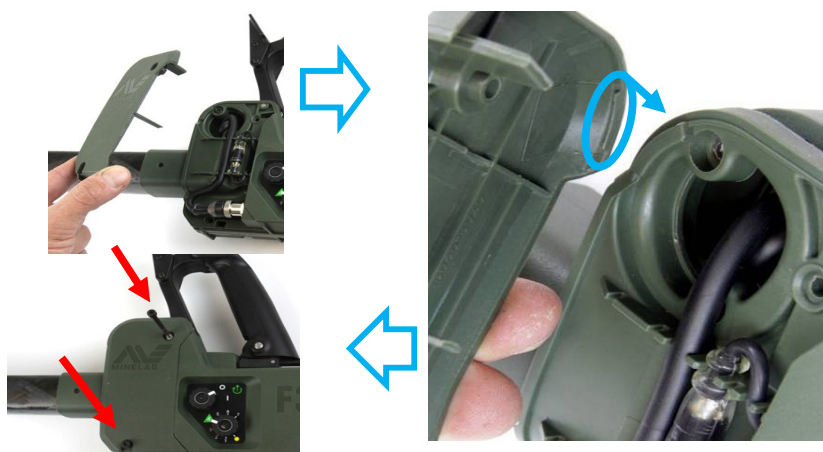

Figure 26: Fitting Hinge Cover

- Reattach the armrest with four screws (12mm).



Figure 27: Attaching the Armrest

- Check all moving parts for correct operation.
- Insert batteries, turn on the detector then conduct mechanical & functional testing as described in Section 2 [Mechanical & Functional Testing](#).

3.3 Main Printed Circuit Board (PCB)

- The main PCB of the F3Ci is a line replaceable unit and this section of the manual describes the procedure for its replacement. Figure 28 shows the main parts associated with the main PCB.
- 3004-0133 Main PCB Kit, is a service kit containing the main PCB and the associated parts, when a replacement main PCB is required this part number should be ordered.

Note

Repairs to and disassembly of the main PCB are not detailed in this manual. Repairs to the main PCB should only be conducted by authorised Minelab Engineers.

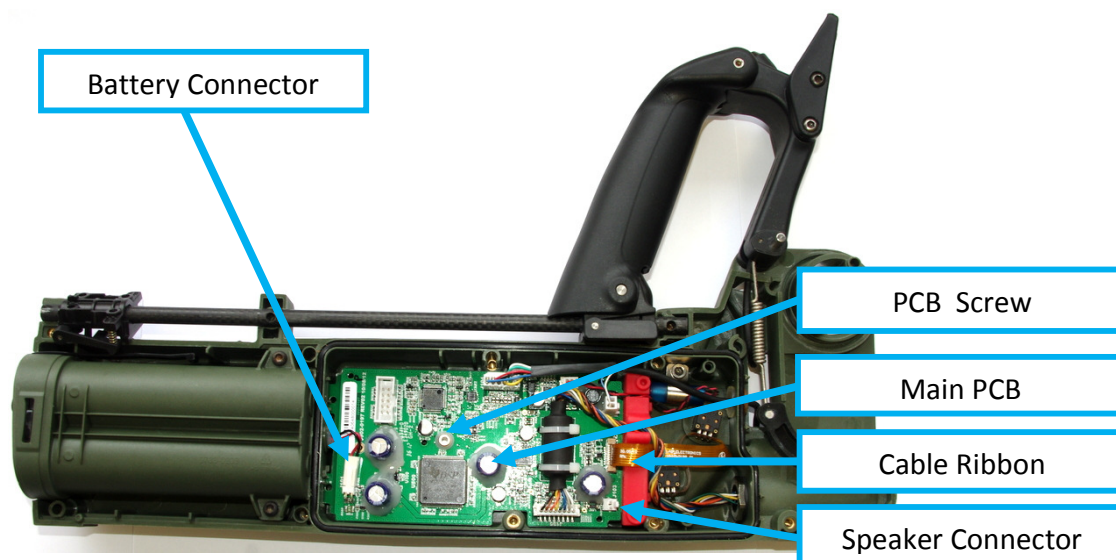

Figure 28: Detector Body and Main PCB



Figure 29: Parts of the Main PCB

1	3004-0133	Main PCB Kit , contains all parts in this table.
6	4311-0089	Bracket Main PCB

Table 1: Parts of Main PCB

3.3.1 Removing the Main PCB

- a. To remove the main PCB, open the detector body as described in section [3.1 - Opening the Detector Body](#) and:

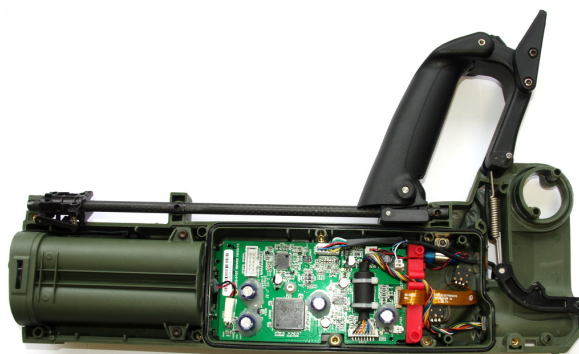

Figure 30: Opened Detector Body

- Remove the Nut (18mm) from the coil connector. Figure 31.



Figure 31: Removing the Coil Connector Nut (18mm)

- Remove the PCB screw from the main PCB, using a 2.5mm hex key driver.
- Disconnect the battery connector from the main PCB.

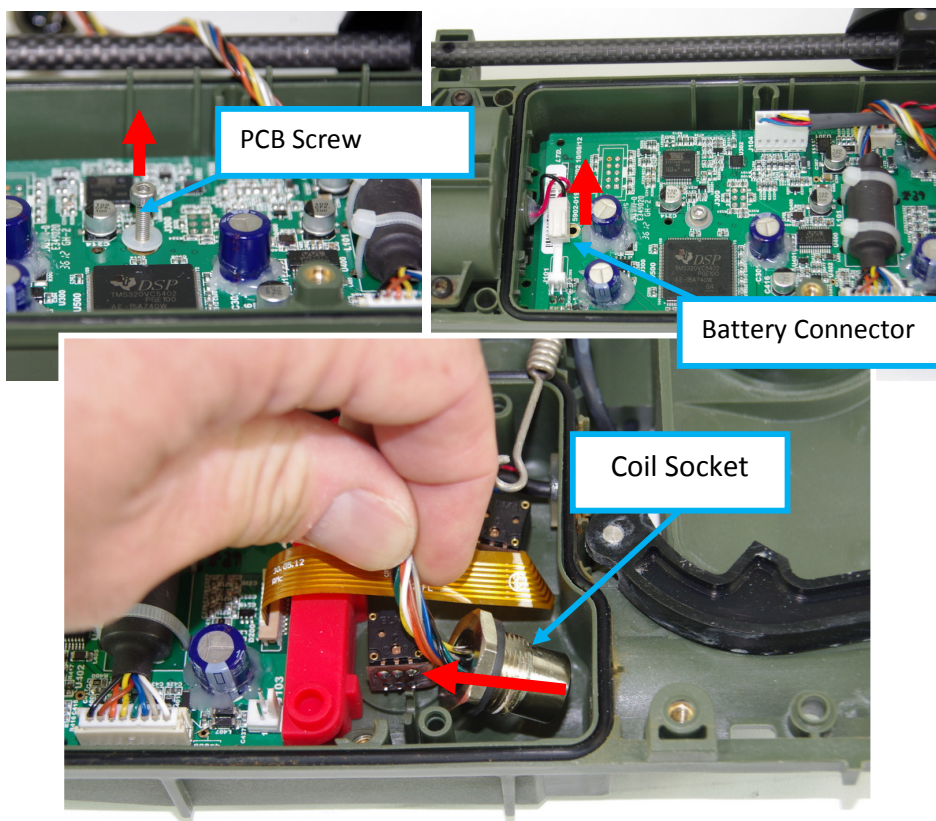

Figure 32: PCB Screw, Battery Connector and Coil Socket

- Slide the coil socket out of the detector body.
- Disconnect the Earset cable assembly (internal) from the main PCB. Figure 33.
- Disconnect the handle wiring loom from the main PCB.
- Disconnect the vibration motor connector from the main PCB.

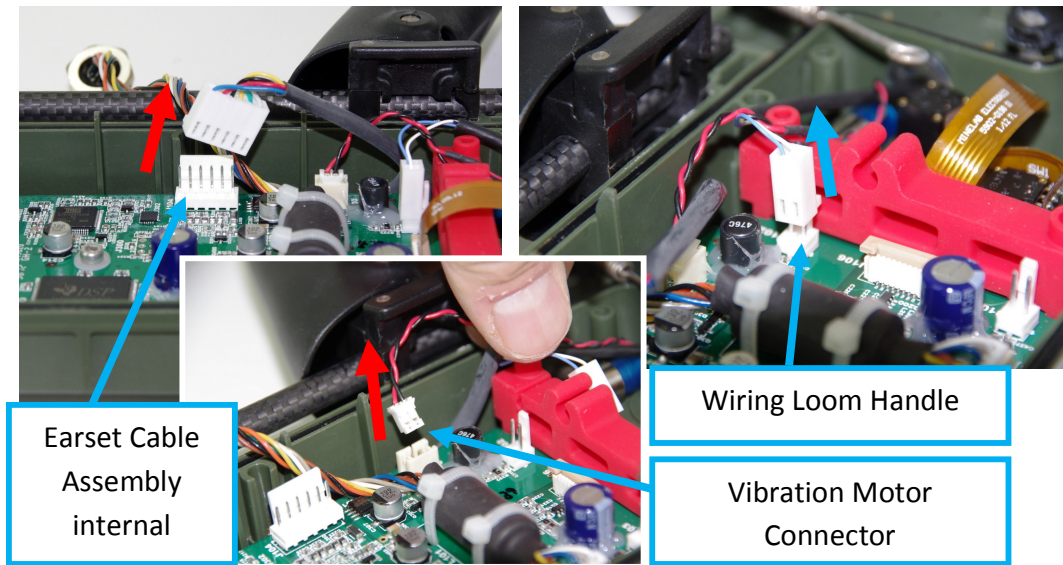

Figure 33: Disconnect Connectors on main PCB

- Identify the ribbon cable connector on the main PCB which connects to the switches.
- Lift open the locking bails on the ribbon cable connector this allows the ribbon cable to be removed and inserted.
- Gently slide the ribbon cable out of the connector.

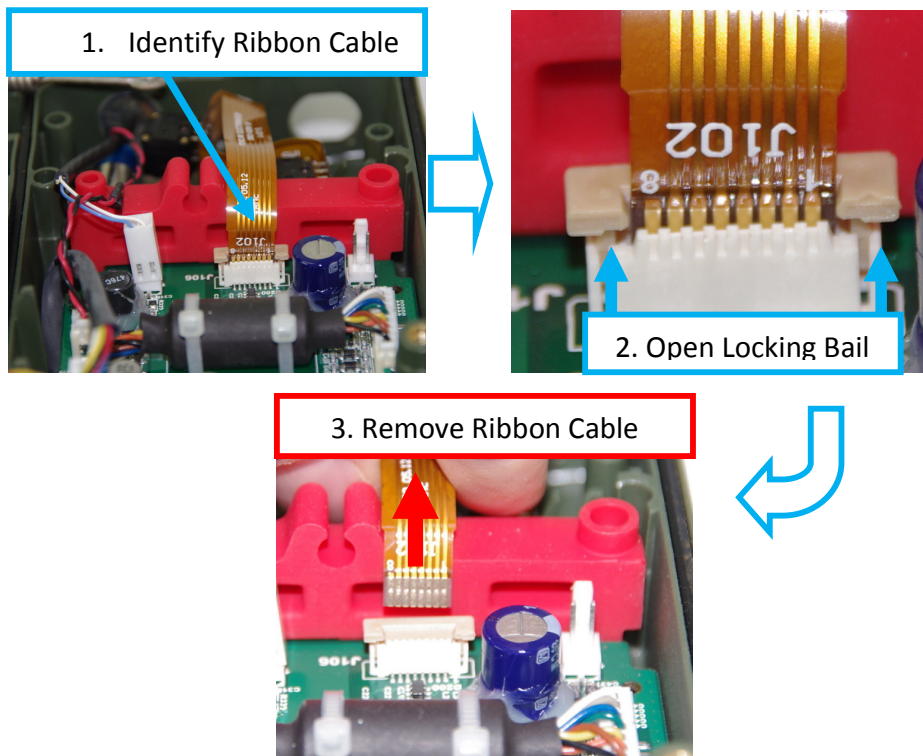

Figure 34: Disconnect the Ribbon Cable

- Slide the main PCB away from the battery assembly until the ends of the main PCB disengage from the slots in the detector body near the battery compartment.
- Gently lift the main PCB out of the detector body.

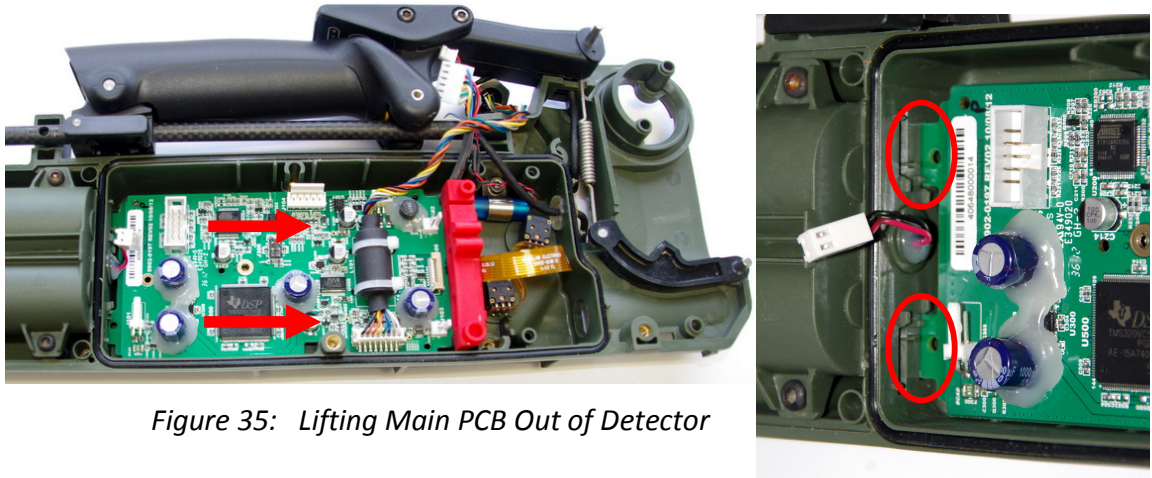

Figure 35: Lifting Main PCB Out of Detector

- b. The main PCB can now be replaced.

3.3.2 Installing the Main PCB.

- a. Having opened the detector body and removed the main PCB, install a serviceable main PCB as follows:

- Place the detector on its left side in a clean well lit area.

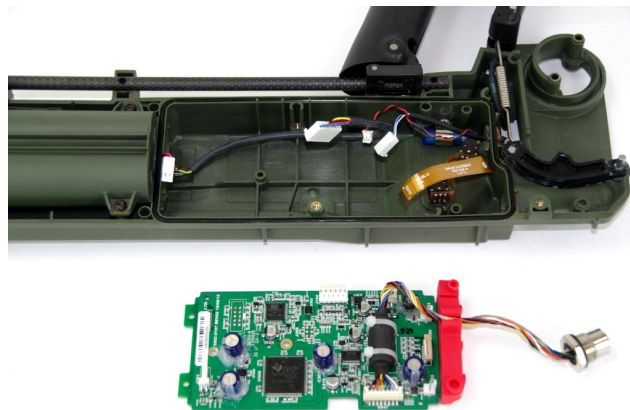

Figure 36: Main PCB

- Lower the main PCB into the detector, gently position the main PCB flat inside the detector body.
- Gently slide the main PCB rearward towards the battery compartment so that the ends of the main PCB insert into the locating slots in the detector body.

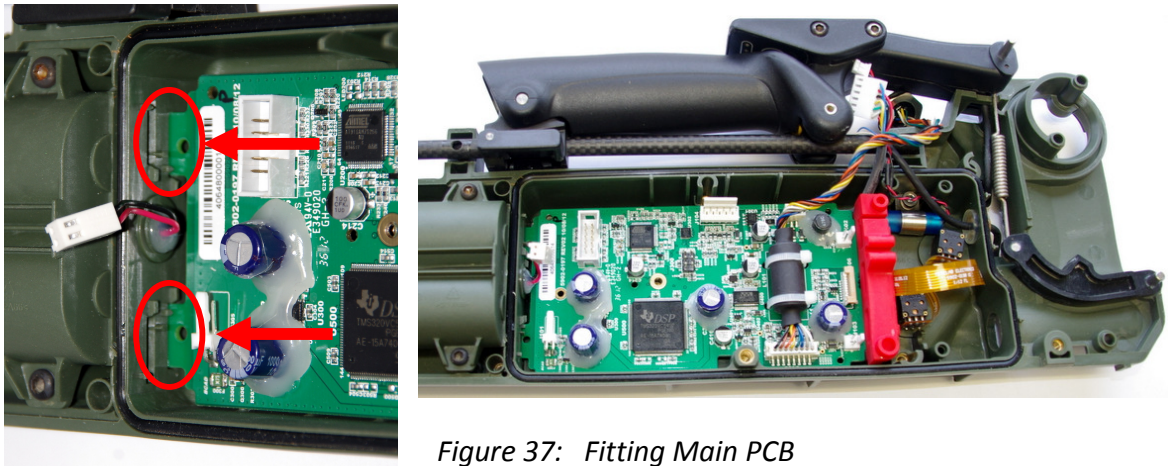

Figure 37: Fitting Main PCB

- Fit the PCB screw as shown in Figure 38.

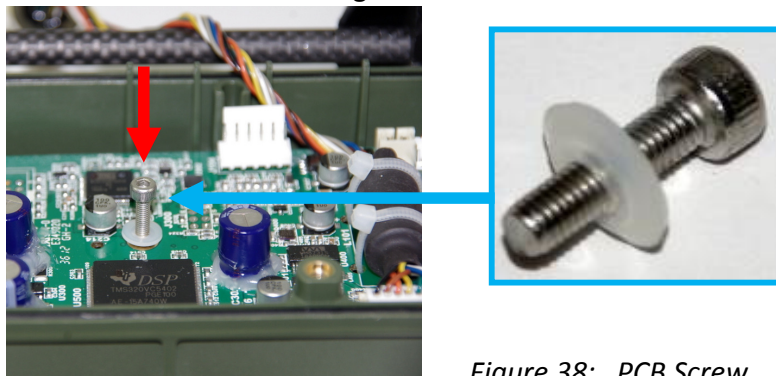

Figure 38: PCB Screw

- Position the coil connector ensuring the connector has a clean and correctly positioned O-ring as shown in Figure 39.
- Fit coil cable into cable router. Turn the detector over and fit the nut (18mm) to the Coil Socket.

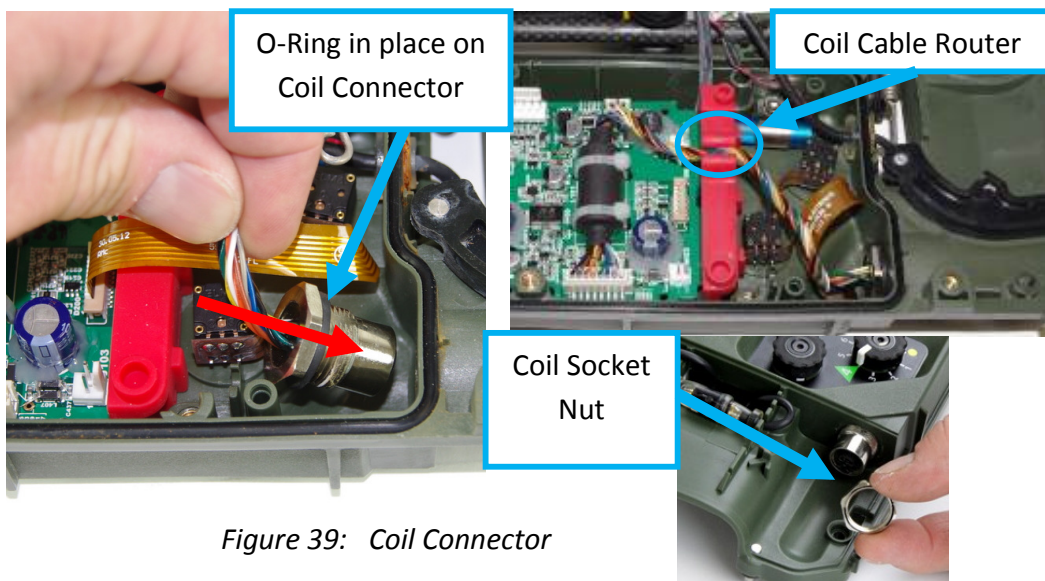

Figure 39: Coil Connector

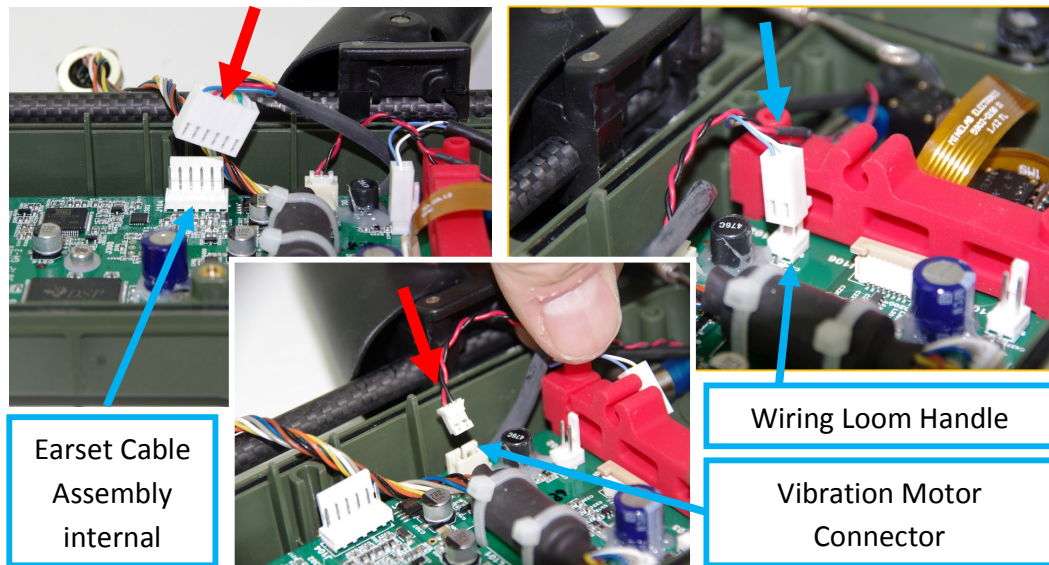

Figure 40: Connectors

- Align the ribbon cable with its connector. Slide the connector locking bails outwards (up) to accept the ribbon cable.
- Insert the ribbon cable into the connector then push the locking bail in to secure.

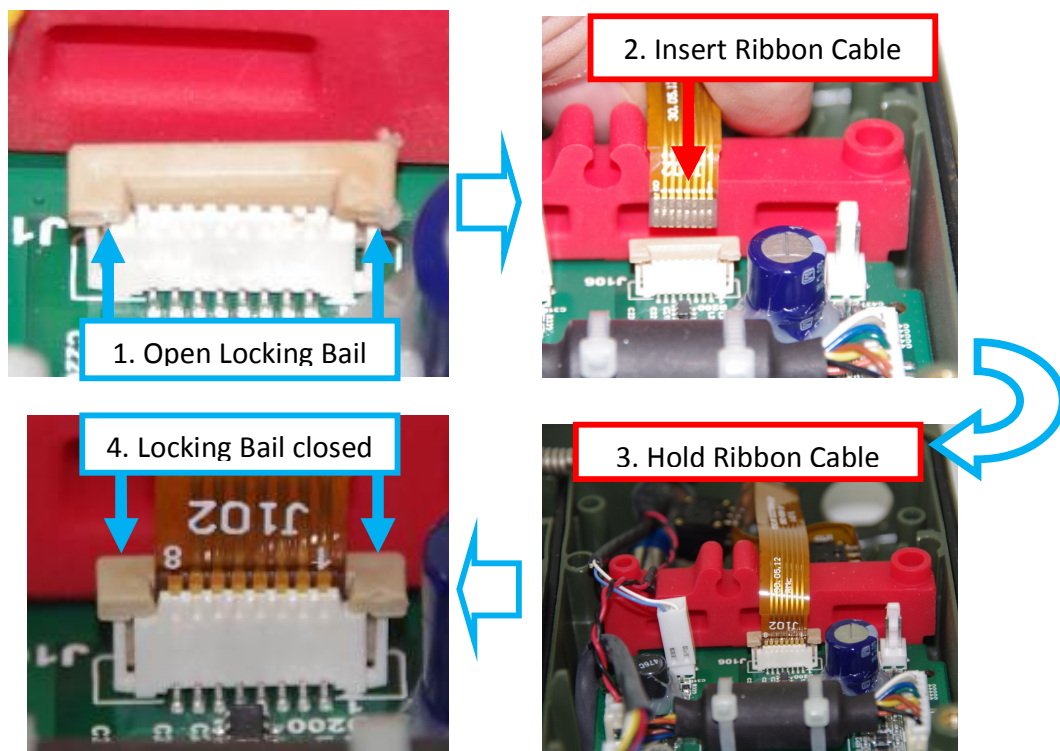

Figure 41: Connecting Ribbon Cable

- Connect the battery connector to the main PCB.

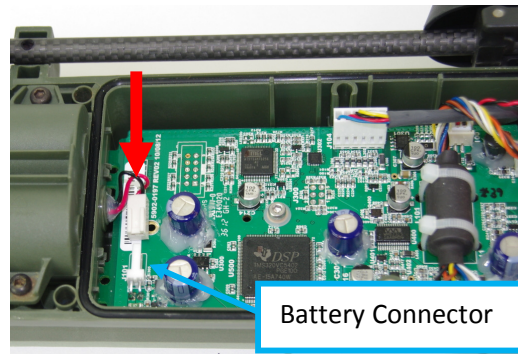

Figure 42: Connecting Battery Connector

- Make sure all connectors are firmly in place and all wires and cables are positioned so that they will not cause obstruction or get damaged when the two halves of the main body are fitted together.



Figure 43: and Coil Socket Nut

- Check the coil socket nut (18mm) is done up tightly.
- b.** Finish assembling the detector by closing the detector body, as described in Section [3.2 – Closing the Detector Body](#)

3.4 Coil

a. The coil is a line replaceable unit (LRU) and figure 44 illustrates the major parts of the coil. 3004-0135 Coil Kit , is a service kit containing the coil and associated parts. 3004-0130 Coil Pivot Kit is an LRU and is included in the 3004-0135 Coil Kit LRU. All parts are available individually.

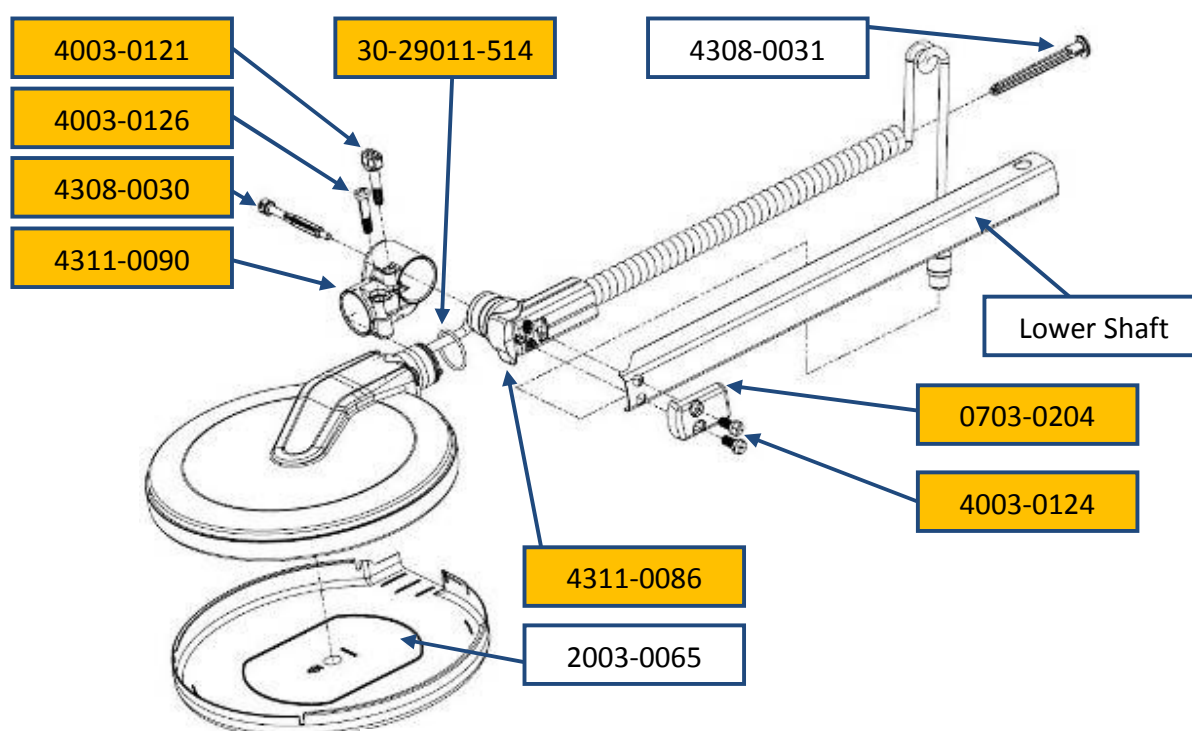

Figure 44: Parts of the Coil

1	3004-0135	Coil Kit, Includes all items in this table
2	2003-0065	Skid Plate
3	3004-0130	Coil Pivot Kit, included parts marked yellow
4	30-29011-514	O Ring 25mm ID
5	4311-0090	Pivot Coil Yoke
6	4311-0086	Pivot Lower Shaft
7	4003-0126	Screw Nylon M6x29
8	4003-0124	Screw Nylon M6x14
9	4003-0121	Screw Thumb Nylon 1/4BSW
10	0703-0204	Cap Shaft
11	4308-0030	Pin Coil Pivot
12	4308-0031	Pin Coil Cable

Table 2: Coil Parts

3.4.1 Skid Plate Replacement

a. The skid plate is designed to protect the coil and may require replacement after long periods of use. There is no requirement to remove the skid plate to clean inside during routine maintenance or operation. To exchange the skid plate:

- Remove the skid plate using fingers to lever one side away from the coil. Place a match stick in the opening or something soft that will not mark the coil or skid plate.
- Move around the circumference of the coil using fingers to lever the skid plate away from the coil. Insert additional match sticks to stop the skid plate from re-attaching to the coil. The skid plate can then be removed from the coil

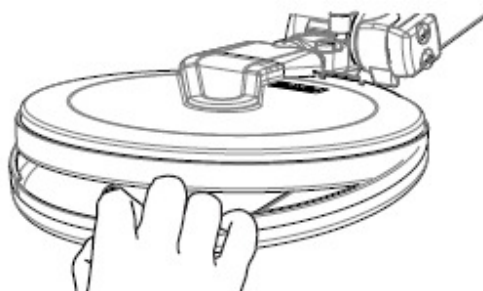

Figure 45: Replacing the Skid Plate

Note

Do not use a knife, screwdriver or any other steel objects to remove the skid plate. This could mark or damage the coil or skid plate.

- Re-attach the skid plate by positioning the skid plate underneath the coil and then pressing it into position.

3.4.2 Removing the Coil

a. To remove the coil:

- Prepare a clean well lit area in which to work.
- Turn the detector off and remove the batteries.
- Place the detector on its right side and remove the two screws (45mm) that secure the hinge cover. Figure 46.
- Remove the hinge cover.



Figure 46: Remove Hinge Cover

- Unscrew and disconnect the coil connector.



Figure 47: Disconnecting Coil Connector

- Remove the pin coil cable from the upper end of the upper shaft. Turn the pin clockwise then pull to remove.

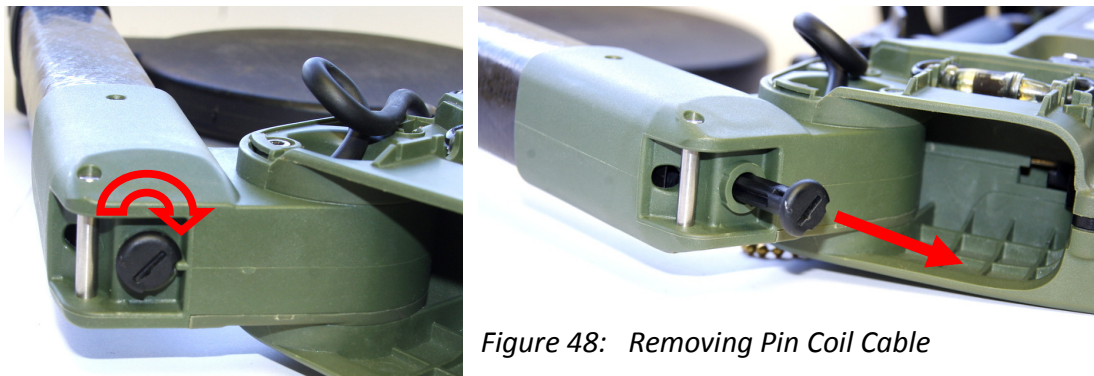

Figure 48: Removing Pin Coil Cable

- Remove the two screws (Nylon 14mm) from the cap shaft on the lower shaft as indicated in Figure 49.

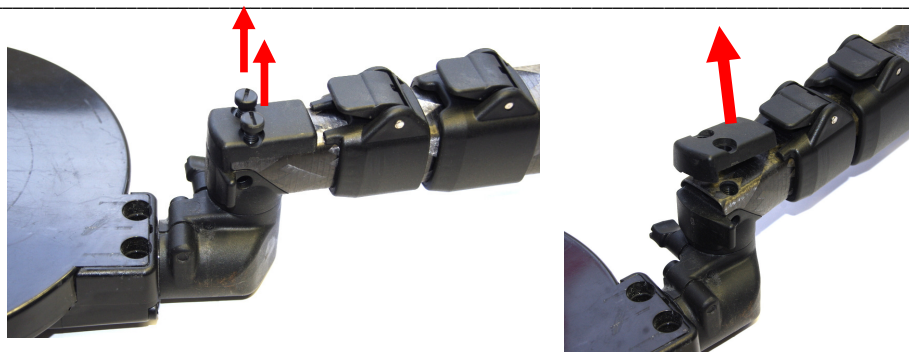

Figure 49: Removing Screws from Lower Shaft

- Insert a flat tip screwdriver into the slot underneath the cap shaft and lift and remove the cap shaft.
- Slide the coil out and off the lower shaft, exposing the coil cable.

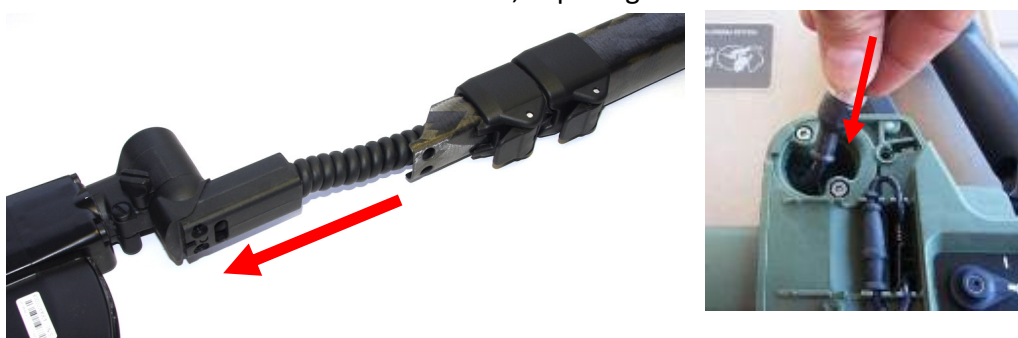

Figure 50: Sliding the Coil Off the Shaft

- Push the coil cable connector into the shaft hinge whilst gently pulling the coil cable out of the end of the lower shaft. Once the coil connector has passed through the shaft hinge it should slide out easily from the shafts. **Do not force the coil cable or coil connector.**
- b. The coil can now be removed or replaced as required. To fit the coil to the detector refer to section [3.4.6 - Fitting the Coil](#).



Figure 51: Coil Assembly.

3.4.3 Coil Pivot.

- a. The coil pivot is a line replaceable unit and Figure 55 illustrates the major parts. Each part of the coil pivot can be ordered individually or as a 3004-0130 Coil Pivot Kit which includes all parts shown in Table 3.



Figure 52: Coil Pivot Kit Parts

1	3004-0130	Coil Pivot Kit , contains all items in this Table
2	30-29011-514	O-Ring 25mm ID x2
3	4311-0090	Pivot Coil Yoke
4	4311-0086	Pivot Shaft
5	4003-0126	Screw Nylon M6x29
6	4003-0121	Thumb Screw Nylon 1/4BSW
7	4308-0030	Pin Coil Pivot
8	4003-0124	Screw Nylon M6x14
9	0703-0204	Cap Shaft

Table 3: Coil Pivot Kit Parts

3.4.4 Removing Coil Pivot

a. To remove the coil pivot, first remove the coil as described in section [3.4.2 - Removing the Coil](#). Once completed:

- Remove the thumb screw and screw (Nylon M6x29).



Figure 53: Removing Two Screws

Note

The two screws can be used to adjust the friction of the coil pivot movement.

- Push the pin coil pivot out with a pin punch or hex key driver and remove the pin coil pivot.

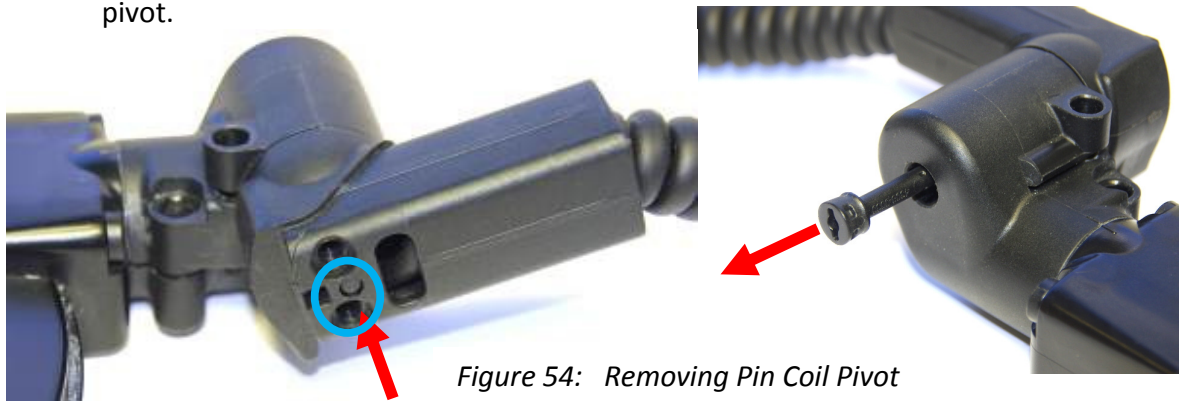

Figure 54: Removing Pin Coil Pivot

- Separate the pivot lower shaft from the pivot coil yoke. Gently feed the coil cable through the pivot lower shaft removing the pivot shaft from the coil cable. Do not stretch the coil cable.

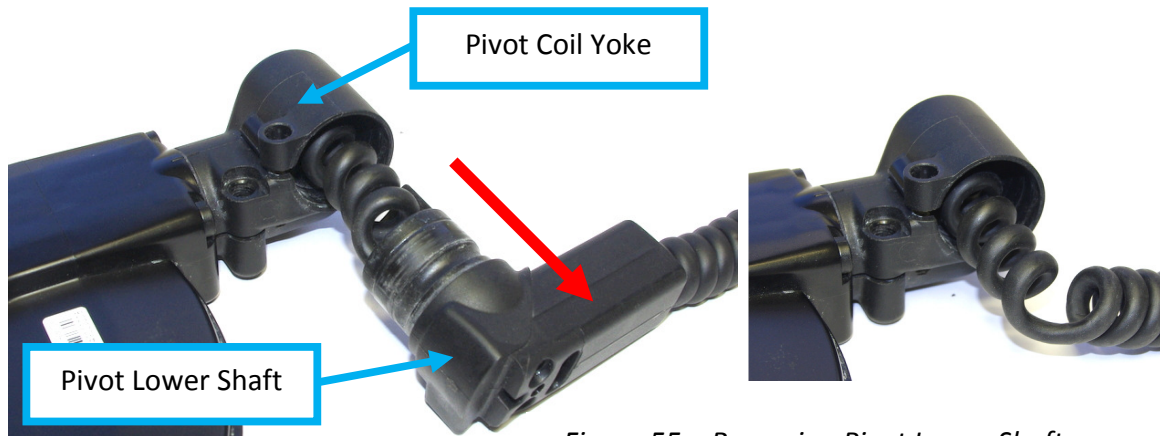

Figure 55: Removing Pivot Lower Shaft

- Pull the pivot coil yoke off the coil and carefully thread the coil cable through the pivot coil yoke. If required remove the O-ring from the coil.

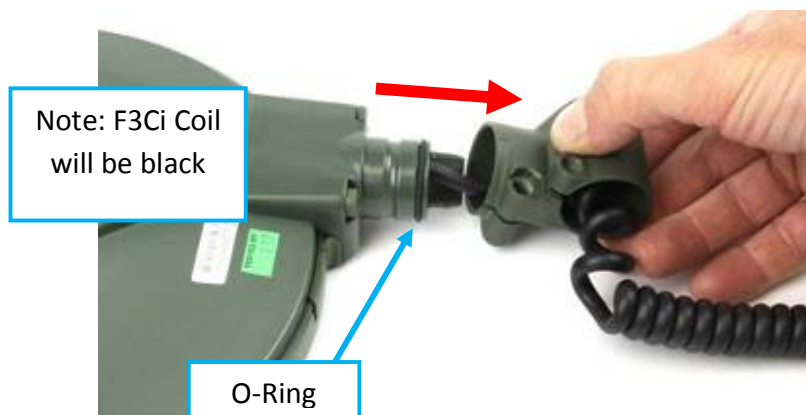

Figure 56: Removing Pivot Coil Yoke

3.4.5 Fitting the Coil Pivot

- a. To fit the coil pivot, firstly remove the coil from the detector as described in section [3.4.2 Removing the Coil](#). Once completed:

- Fit the O-ring to the coil as shown in Figure 60.



Figure 57: O-Ring and Coil Cable

- Identify the section of coil cable closest to the coil and wind or unwind the coil cable to achieve five turns. The five turns of cable will be located within the pivot with the pin coil pivot passing through the centre.
- Feed the pivot coil yoke onto the coil cable and carefully move the pivot coil yoke along the coil cable to the coil. Align and then push the pivot coil yoke into place on the coil. Check the pivot coil yoke rotates through 90 deg with end stops.

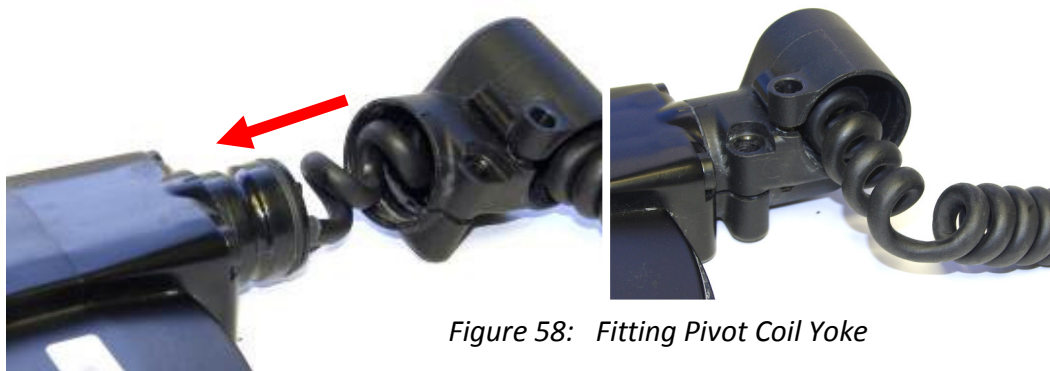

Figure 58: Fitting Pivot Coil Yoke

- Feed the pivot shaft onto the coil cable. Align the coil cable with the five turns of cable inside the pivot then press the pivot shaft onto the pivot coil yoke. Ensure the coil cable retains the five turns of cable within the pivot.

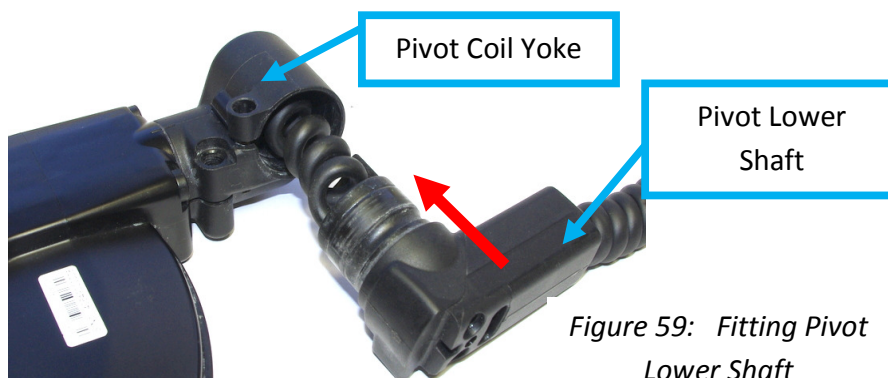

Figure 59: Fitting Pivot Lower Shaft

- Push the pin coil pivot into the pivot coil yoke. The pin must travel up the centre of the five turns of cable inside the pivot. If there is resistance to inserting the pin open the pivot and try again. **Do Not Use Excessive Force.** Push the pin in with fingers and click into place.

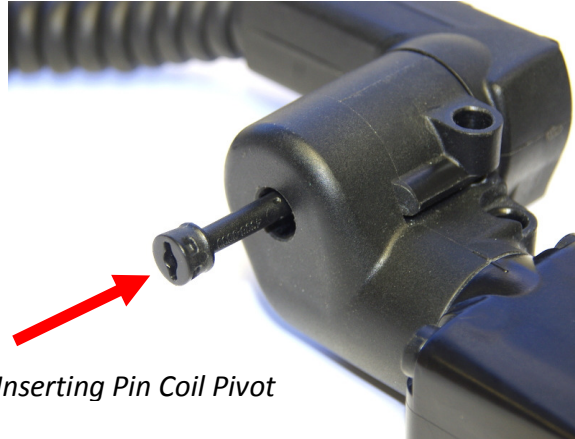

Figure 60: Inserting Pin Coil Pivot

Note

The pin coil yoke must thread through five turns of the cable inside the pivot.

- Check the movement of the pivot in both directions.
- Fit the screw (Nylon M6x29) into the pivot coil yoke and then fit the thumb screw. Tighten both screws until the movement of the coil starts to become firm.



Figure 61: Fit Adjusting Screws

Note

The thumb screw will adjust the friction of the coil tilt. The thumb screw must be tight enough to stop the coil from drooping. The screw (Nylon M6x29) will adjust the friction of the coil rotation.

- Fit the coil to the shaft then fit onto the detector as described in Section [3.4.6 - Fitting the Coil](#).

3.4.6 Fitting the Coil

- a. With practice and a pull through tool it is possible to fit the coil to the detector without opening the detector body and removing the detector shafts.



Figure 62: Coil LRU

- Connect the coil cable pull-through to the coil connector. Alternatively, a piece of string could be used to thread the coil cable into the shafts.
- Extend the lower and middle shaft 2 cm (1 in) and position the shaft at 90 degrees to the detector body.
- Feed the coil cable pull-through into the coil end of the lower shaft and out through the detector hinge. Feed the coil cable until the coil connector is exposed.



Figure 63: Threading Coil Cable through Shafts

- Insert the pin coil cable into the end of the upper shaft so that the pin engages into the turns of the coil cable within the shaft. Turn the pin counter clockwise to lock it into place.

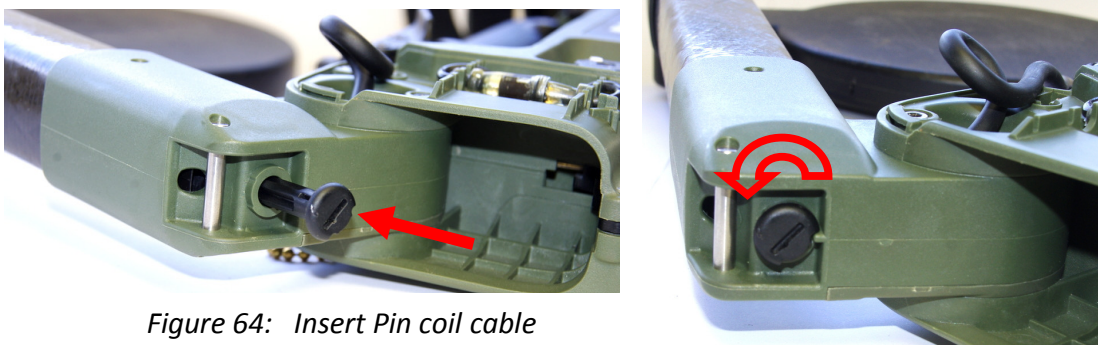

Figure 64: Insert Pin coil cable

- Slide the coil into the end of the lower shaft. Fit the cap shaft then fit the two screws (14mm Nylon). Figure 65.

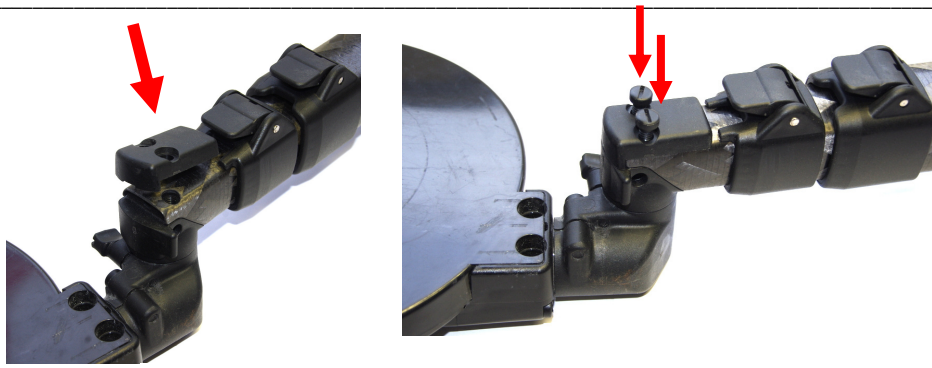

Figure 65: Fit cap shaft and screws

- Thread the coil cable through the detector hinge and align the coil connectors. Tighten coil connector.
- Fit coil cable into cable router then replace the hinge cover.

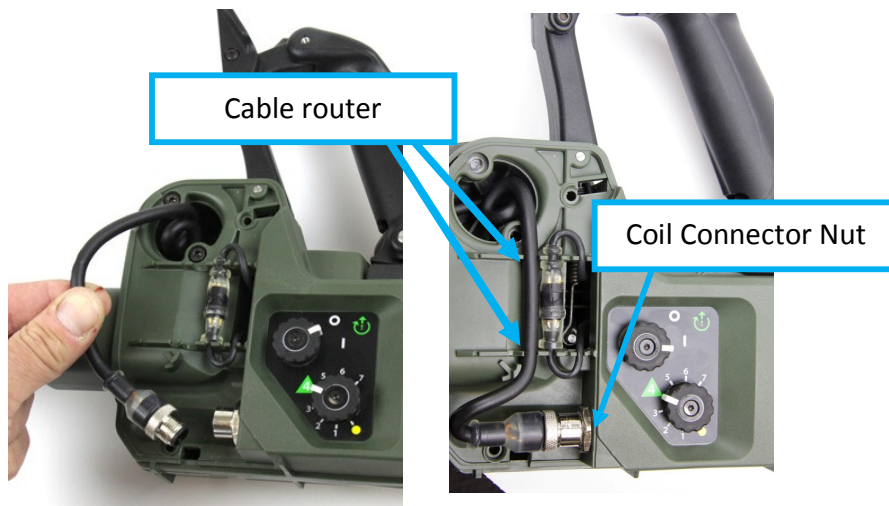

Figure 66: Connecting Coil Cable and Cover

- Check the latch and spring are connected as shown in Figure 67. If the latch and spring have become disconnected they must be reconnected. It is possible to reattach the eyelet of the spring to the pin of the latch hinge through the opening under the hinge cover. Alternately the detector body can be opened to reattach the spring to the latch.

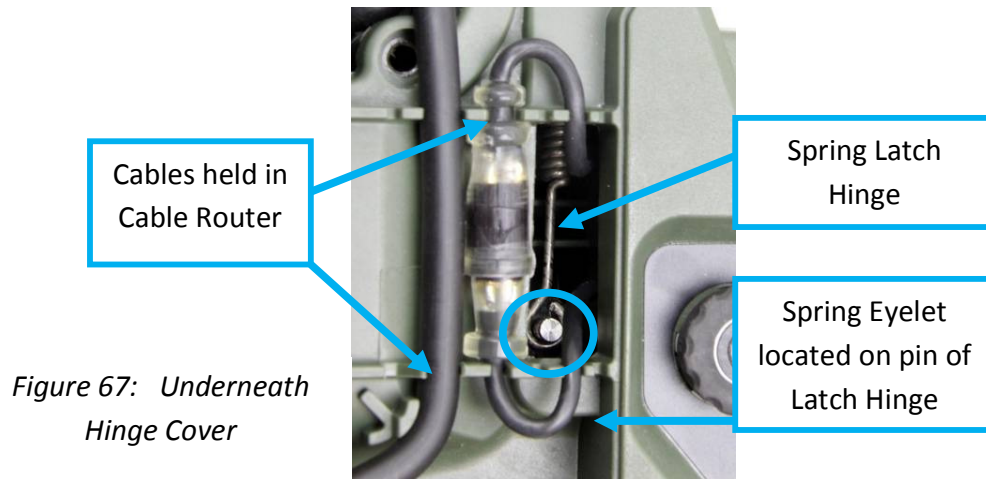

Figure 67: Underneath Hinge Cover

- Fit the hinge cover making sure the protrusion on the underside of the hinge cover engages into the slot on the detector body near the hinge. Fit the two screws (45mm) into the hinge cover and tighten.

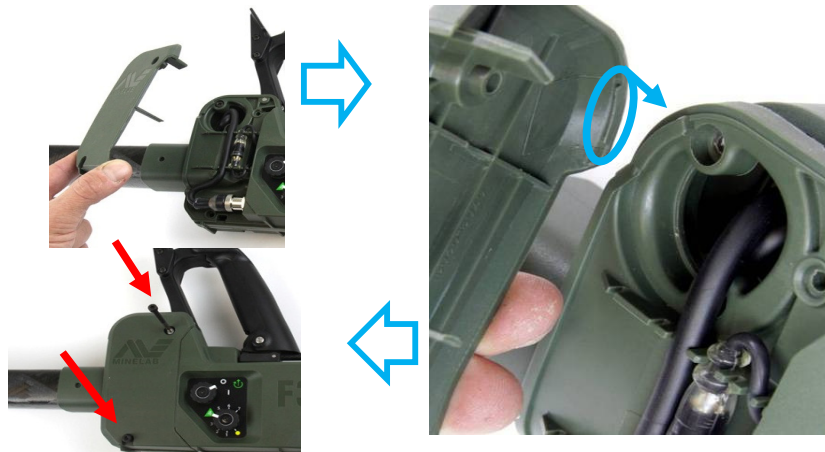

Figure 68: Fitting Hinge Cover

- c. The coil has now been fitted to the detector. Check the assembly and all moving parts. Insert batteries and then carry out mechanical & functional testing as described in Section [2 - Mechanical & Functional Testing](#).

3.5 Shafts

a. The complete shaft assembly of the detector is a line replaceable unit and Figure 71 illustrates the major parts.

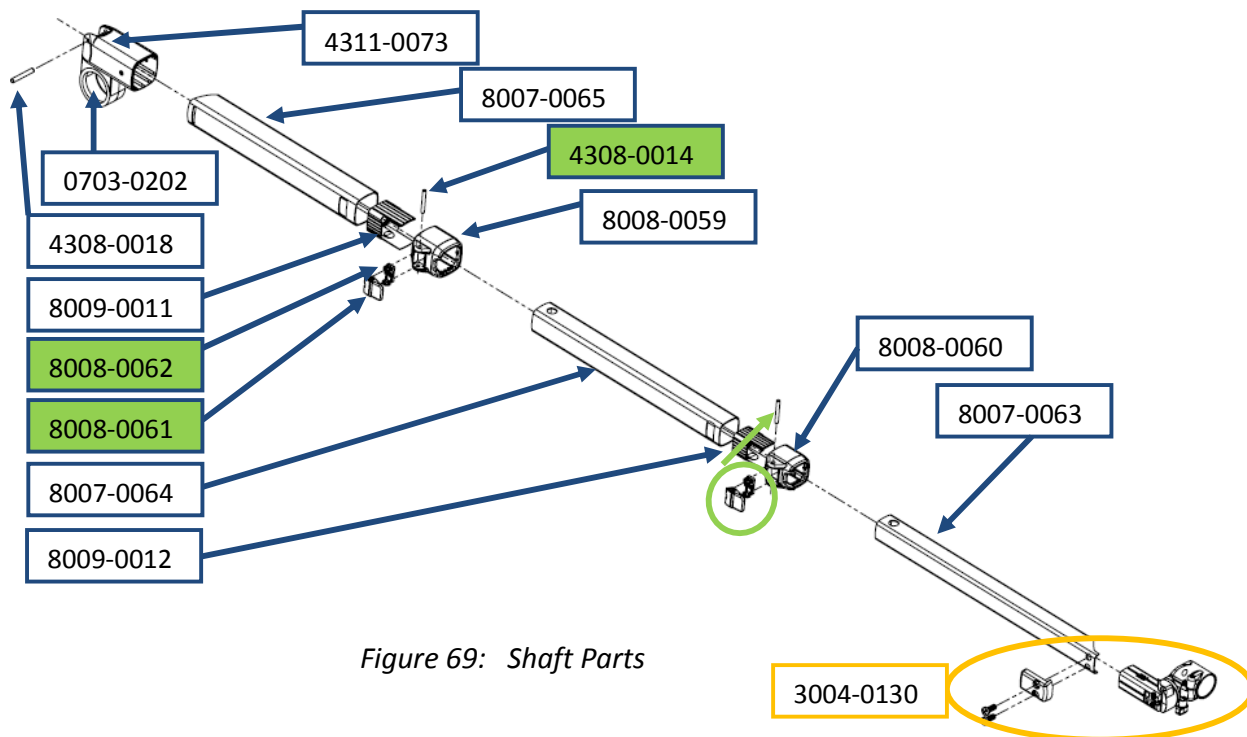

Figure 69: Shaft Parts

1	3004-0046	Shaft Kit , contains all items in this table
2	3004-0130	Coil Pivot Kit
3	3004-0047	Camlock Kit , contains 3 items marked green
4	8008-0062	Pressure Block Camlock
5	8008-0061	Camlock Lever
6	4308-0014	Pin Camlock Lever
7	4308-0018	Pin Lock Latch
8	4311-0073	Hinge Upper Shaft
9	8007-0065	Shaft Upper
10	8009-0011	Shaft Guide Middle
11	8008-0059	Camlock Body Upper
12	8007-0064	Shaft Middle
13	8009-0012	Shaft Guide Lower
14	8008-0060	Camlock Body Middle
15	8007-0063	Shaft Lower
16	0703-0202	Cover Shaft Hinge
17	31-03512-982	Screw 3.5x12 skt head

Table 4: Shaft Parts

3.5.1 Replacing a Camlock

a. Camlock replacement can be achieved as follows:

- Open the camlock lever and using a pin punch and hammer drive the camlock pin out.

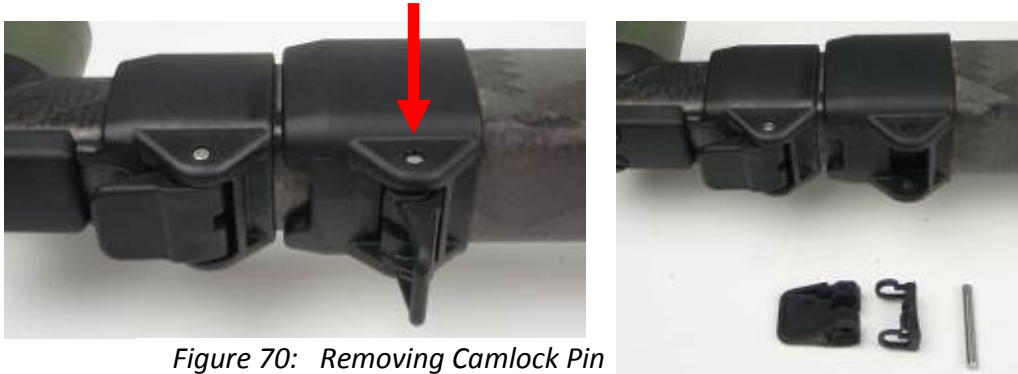

Figure 70: Removing Camlock Pin

- Once the camlock pin has been removed the camlock pressure block can be removed and replaced if needed.

Note

When the camlocks are closed they must hold the shafts firmly with no slippage. If the camlock does not hold the shafts firmly in place then the pressure block should be replaced.

- To assemble the camlock, fit the pressure block to the camlock lever.
- Place the camlock lever with pressure block fitted into position within the camlock body then press the camlock pin into place.



Figure 71: Fitting Camlock Pin

3.5.2 Removing the Shafts

a. To remove the shafts from the detector firstly open the detector body as described in Section [3.1 – Opening the Detector Body](#). Once completed:

- Lift the shafts clear of the detector.



Figure 72: Shaft and Coil removed from Detector

- Remove the pin coil cable from the upper end of the upper shaft. Turn the pin coil cable clock wise and then lift out.

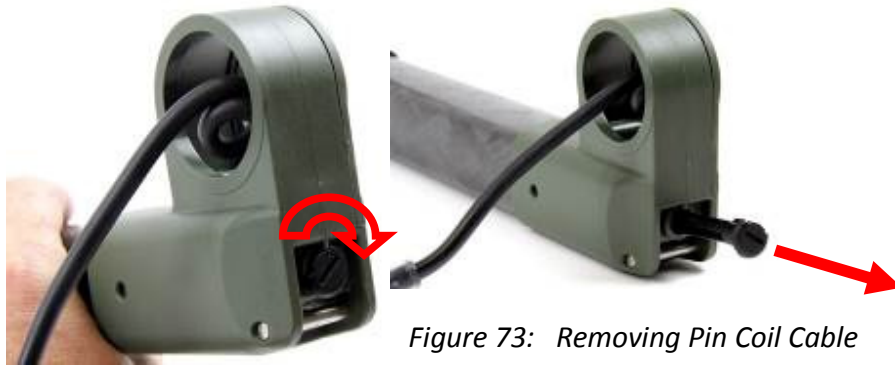

Figure 73: Removing Pin Coil Cable

- Remove the two nylon screws from the cap shaft on the lower shaft as indicated in Figure 74.
- Insert a flat tip screwdriver into the slot underneath the cap shaft and lift and remove the cap shaft.



Figure 74: Removing Screws from Lower Shaft

- Slide the coil out and off the lower shaft, exposing the coil cable. Feed the coil cable connector into the upper shaft and pull the coil cable out of the end of the lower shaft. Figure 75



Figure 75: Removing Coil from Shafts



Figure 76: Detector Shafts Assembly

- b. The shafts have now been removed from the detector and can be replaced if required.

3.5.3 Fitting the Shafts

- a. The detector body needs to be opened in order to fit the shafts to the detector, refer to Section [3.1 – Opening the Detector Body](#).
- b. The coil must be fitted to the shaft then the shaft fitted to the detector this process is described in Section [3.4.6 - Fitting the Coil](#).
- c. Assemble the detector as described in Section [3.2 - Closing the Detector Body](#).
- d. Once the detector is fully assembled check the operation of all moving parts and test the detector as described in Section [2 - Mechanical & Functional Testing](#).

3.6 Handle

a. The handle assembly is a line replaceable unit and Figure 77 illustrates the major parts of the handle.

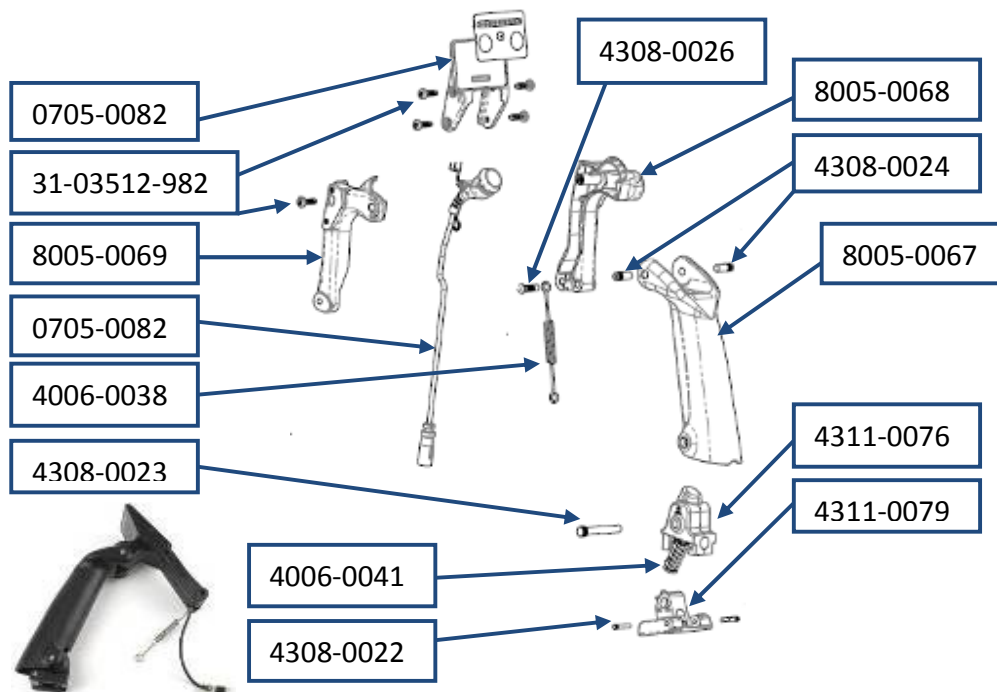

Figure 77: Handle Parts

1	3004-0132	Handle Kit , contains all items in this table.
2	0703-0207	Display Assembly LED
4	31-03512-982	Screw 3.5x12 skt head
5	4006-0038	Spring Latch Hinge
6	4006-0041	Spring Handle Detent
7	4308-0022	Pin Lock Handle Detent
8	4308-0023	Pin Handle Main Lower
9	4308-0024	Pin Handle Main Upper
10	4308-0026	Pin Spring Latch hinge
11	4311-0076	Hinge Handle Slide
12	4311-0079	Lock Handle Slide
13	8005-0067	Handle Main
14	8005-0068	Handle Forward Right
15	8005-0069	Handle Forward Left

Table 5: Handle Parts

3.6.1 Removing the Handle

- a. The detector body must first be opened to remove the handle as described in Section [3.1 - Opening the Detector Body](#). Once completed:



Figure 78: Disconnect Wiring Loom Handle

- Disconnect the wiring loom handle. Hold one side of the connector firm against the detector body whilst gently pulling the other side.
- Disconnect the spring latch hinge from the latch hinge.
- Lift the handle off the pin handle pivot.
- Remove the rod handle slide from the handle.

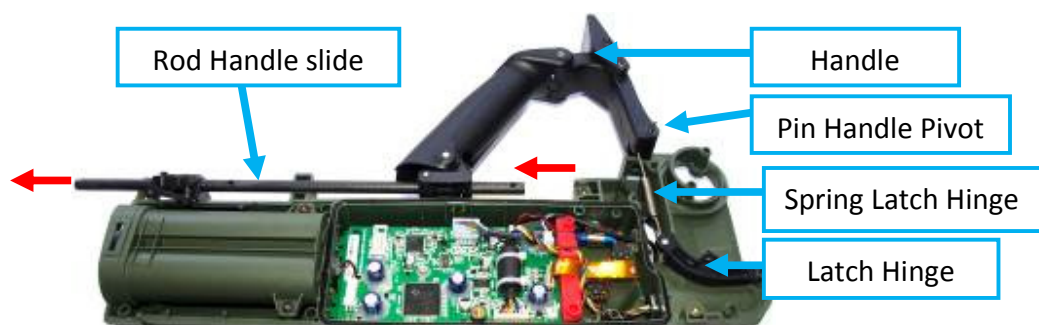

Figure 79: Handle

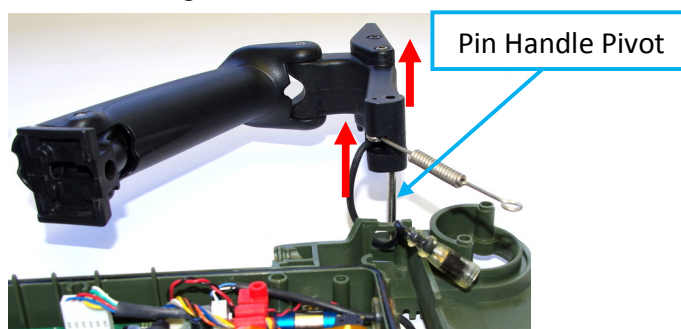

Figure 80: Removing Handle and Cable

- Pass the wiring loom handle through the top of the detector body and lift the handle off the pin handle pivot and away from the detector
- b. The handle has now been removed from the detector and can be replaced if required.

3.6.2 Fitting the Handle

a. To fit the handle the detector body must be opened as described in Section [3.1 - Opening the Detector Body](#). Once completed:

- Thread the wiring loom handle into the detector body.



Figure 81: Threading the Wiring Loom

- Push the handle onto the pin handle pivot.
- Connect the spring latch hinge to the latch hinge.
- Feed the rod handle slide through the handle and into position.

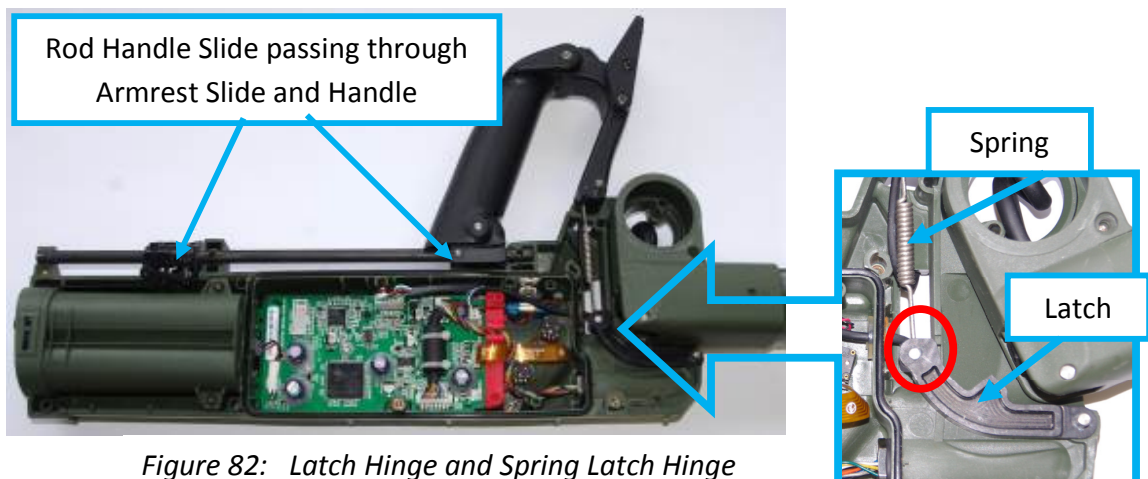

Figure 82: Latch Hinge and Spring Latch Hinge

- Connect the wiring loom handle and fit into the cable router. Figure 83.

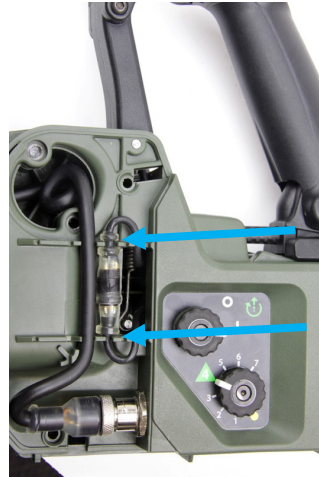
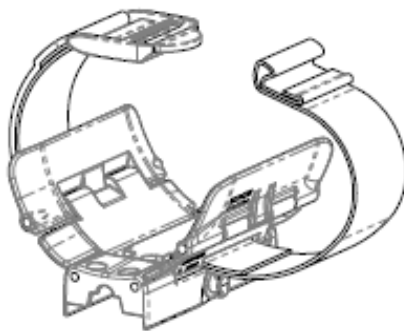

Figure 83: Correct Position of Wiring Loom Handle

- b. Assemble the detector and close the detector body as described in Section [3.2 - Closing the Detector Body](#).

3.7 Armrest

- a. The armrest is a line replaceable unit with or without slide as shown in Figure 86.



3004-0049 Armrest Kit



3004-0048 Armrest Kit with Slide.

Figure 84: Armrest Service Kits

3.7.1 Replacing the Armrest

- a. To replace the armrest:
- Prepare a clean well lit workspace.
 - Turn the detector off and remove the batteries.
 - Remove the four 12mm round head screws from the top of the armrest and remove the armrest.

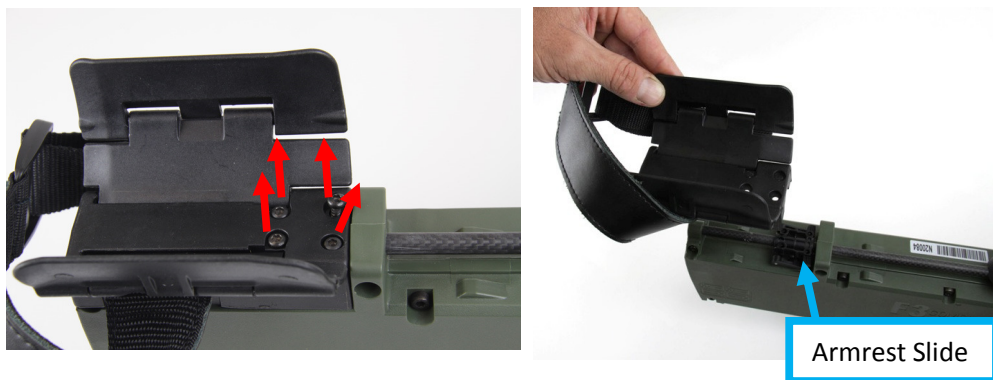

Figure 85: Removing the Armrest

b. The armrest assembly can now be replaced as an assembly. If the armrest slide assembly must also be replaced then the detector body must be opened as described in Section [3.1 - Opening the Detector Body](#).

- Reattach the armrest and fit the four screws (12mm)
- Check the armrest folds in and out correctly and also check that the armrest slides backward and forward.

3.8 Battery Compartment

a. The battery compartment and the battery lid are line replaceable units and available as service kits which include associated parts as shown in Figure 86.

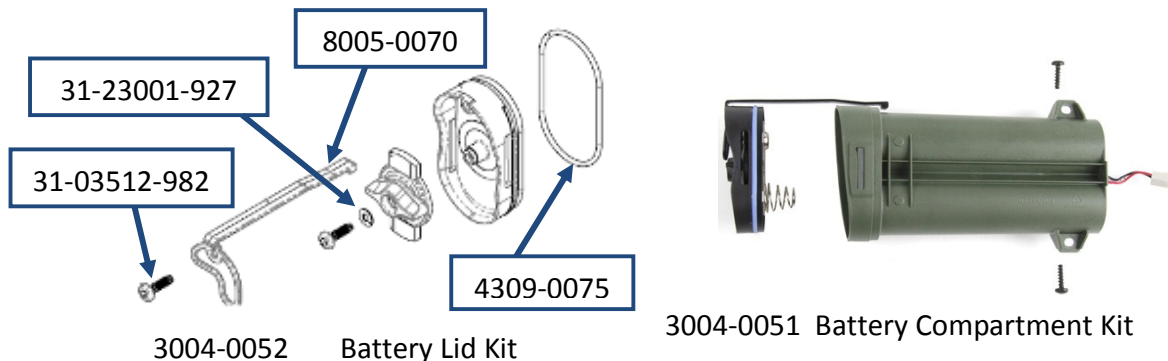

Figure 86: Battery Service Kits

1	3004-0051	Battery Compartment Kit , contains all items.
2	3004-0052	Battery Lid Kit
3	31-03512-982	Screw 3.5x12 skt head
4	31-23001-927	Washer M3 Nylon
5	8005-0070	Tether Battery Lid
6	4309-0075	O-ring Battery Lid

Table 6: Battery Compartment

3.8.1 Battery Lid Replacement

a. Open the detector body as described in Section [3.1 - Opening the Detector Body](#). Once completed:

Note

The battery lid can be replaced without opening the detector body if the tether is unscrewed from the battery lid.

- Check the battery lid has an O-ring correctly in place. The O-ring must be clean and can be lightly greased.
 - Check the battery lid closes onto the battery compartment. Fit and close the battery lid.
- b. Close the detector body as described in Section [3.2 - Closing the Detector Body](#).

3.8.2 Battery Compartment Replacement

a. Open the detector body as described in Section [3.1 - Opening the Detector Body](#). Once completed:

- Disconnect the battery connector. Figure 87.
- Remove the two screws (12mm) from the battery compartment.
- Slide the battery compartment rearward (away from the main PCB), threading the battery connector out of the detector body.

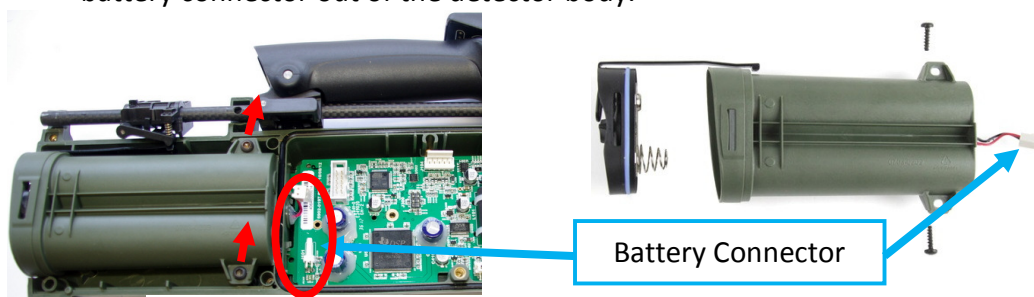

Figure 87: Replacing Battery Compartment

- Refit the battery compartment by first feeding the battery connector through the hole in the detector body.
 - Slide the battery compartment into position.
 - Connect the battery connector.
 - Refit the two mounting screws (12mm).
 - Close and lock the battery lid.
- b. Reassemble the detector by closing the detector body as described in Section [3.2 - Closing the Detector Body](#).

3.9 Detector Body

a. The detector body is not a line replaceable unit. The following assemblies within the detector body are line replaceable units and are available as service kits:

- 3004-0054 Switches kit
- 3004-0056 Wiring Loom Handle Socket Kit
- 3004-0057 Speaker Kit
- 3004-0058 Wiring Loom Earset kit

3.9.1 Control Switches Replacement

a. The control switches are a line replaceable unit and are available as a service kit, 3004-0054 Switches Kit which includes all associated parts. Figure 88 illustrates all parts.

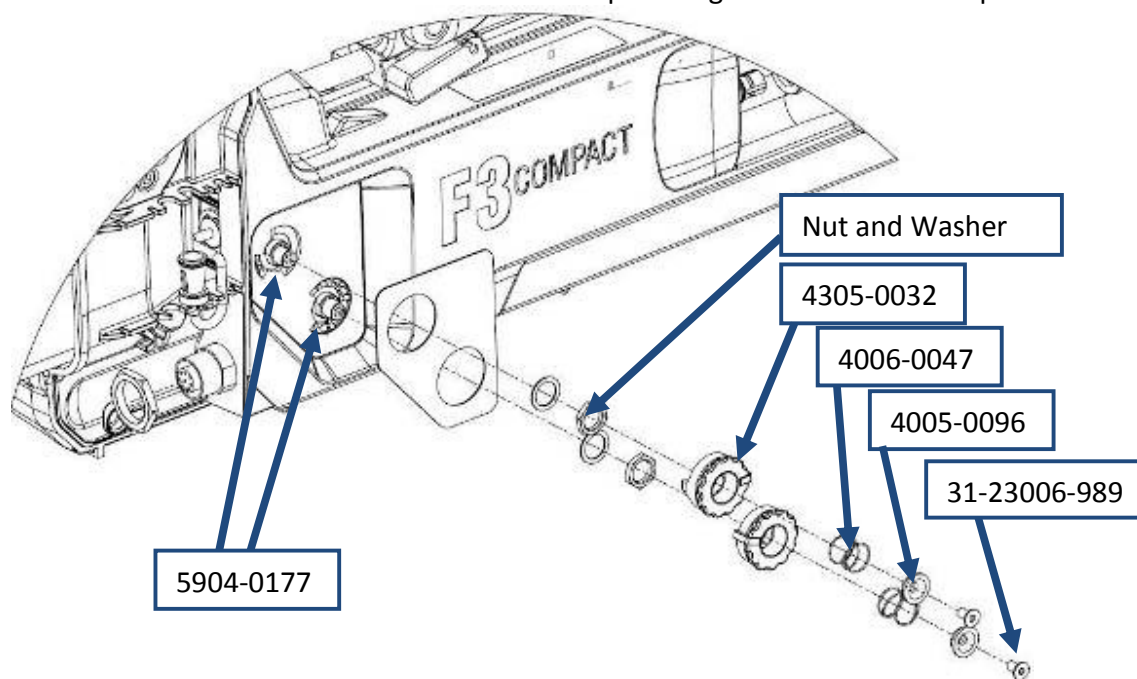

Figure 88: Switches Kit

1	3004-0054	Switches Kit , includes all parts in this table
2	31-23006-989	Screw M3x6 skt csk
3	4005-0096	Bush Knob Lift and Turn
4	4006-0047	Spring Knob Lift and Turn
5	4305-0032	Knob Lift and Turn
6	5904-0177	Switches with Cable includes washer and nut

Table 7: Switches Parts

b. In order to remove or replace the switches first open the detector body as described in Section [3.1 - Opening the Detector Body](#). Once completed:

- Identify the ribbon cable connector on the main PCB which connects to the switches.
- Lift open the locking bails on the ribbon cable connector this allows the ribbon cable to be removed and inserted.
- Gently slide the ribbon cable out of the connector.

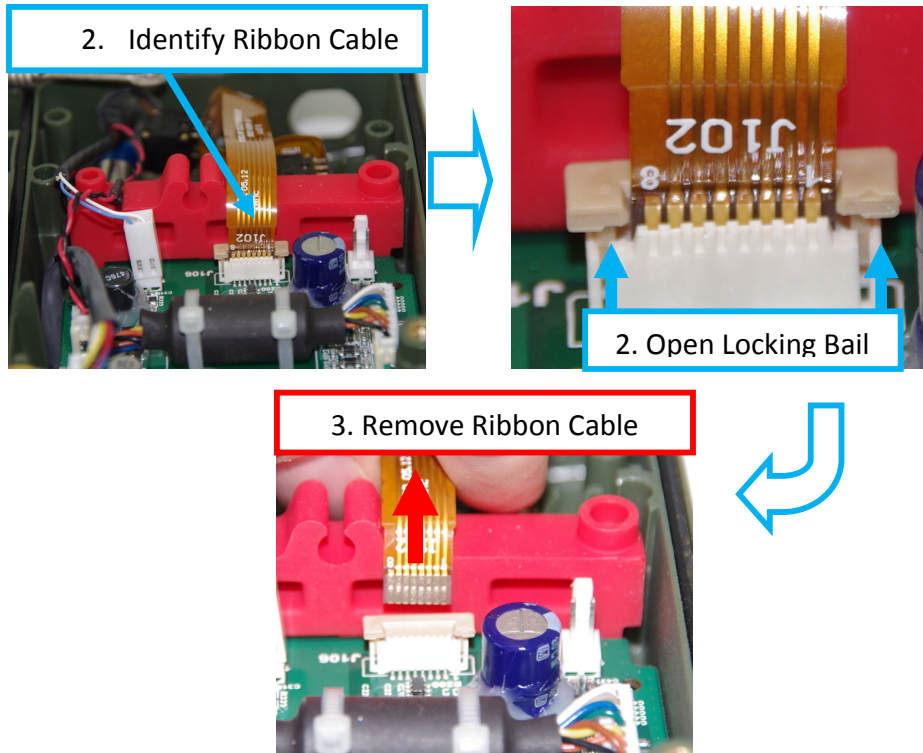

Figure 89: Disconnect the Ribbon Cable

- Lay the detector on its side with the control knobs facing upwards. Set the controls to off and setting 4.

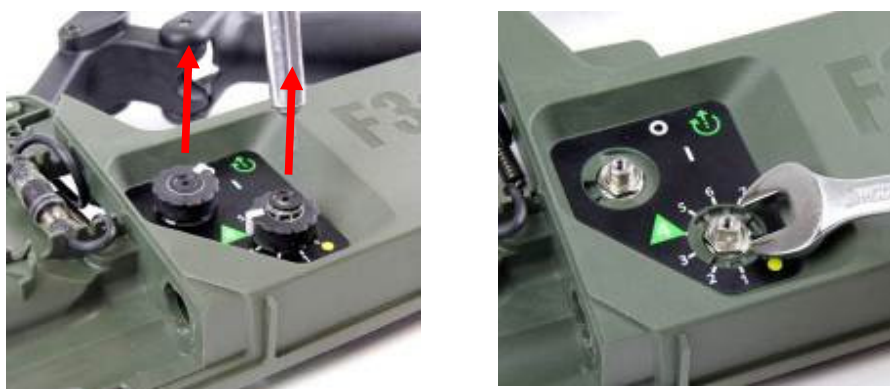

Figure 90: Removing Control Switch Knobs

- Using a 2mm hex key driver, undo the screws in the centre of each control knob and remove the screw, bush, spring and knob from the switches.

- Take note of the orientation of the switches and the ribbon cable and use a 10mm spanner to remove the nut and locking washer from both switches.
- c. The control switches can now be removed and replaced.

Note

Use care handling the control switches and the flexible ribbon cable. These are internal components and will be easily damaged if they are forced or misaligned.

Note

Do not use a soldering iron on the switches or the flexible ribbon cable.

- Check each control switch has a clean and lightly greased O-ring correctly positioned on the mounting face.
- Carefully align the control switches and the flexible ribbon cable within the detector body as illustrated in Figure 91.



Figure 91: Control Switches

- Insert the control switches into the detector body, fit the lock washer and 10mm nut.
 - Fit the switch knob then the spring followed by the bush and screw to the control switch.
 - Check the switch knobs move through their arc of movement with end stops.
 - Identify the connector on the interface PCB that mates with the flexible ribbon cable of the control switches. Open the connector locking bail (slide out). As shown in Figure 89.
 - Insert the ribbon cable into the connector on the interface PCB then close the locking bail on the connector. Also see [Installing the Main PCB](#), figure 44.
- d. Reassemble the detector by closing the detector body as described in Section [3.2 - Closing the Detector Body](#).

3.9.2 Speaker Replacement

a. The speaker is a line replaceable unit and available as a service kit, 3004-0057 Speaker Kit. Figure 92 illustrates the major parts of the speaker.

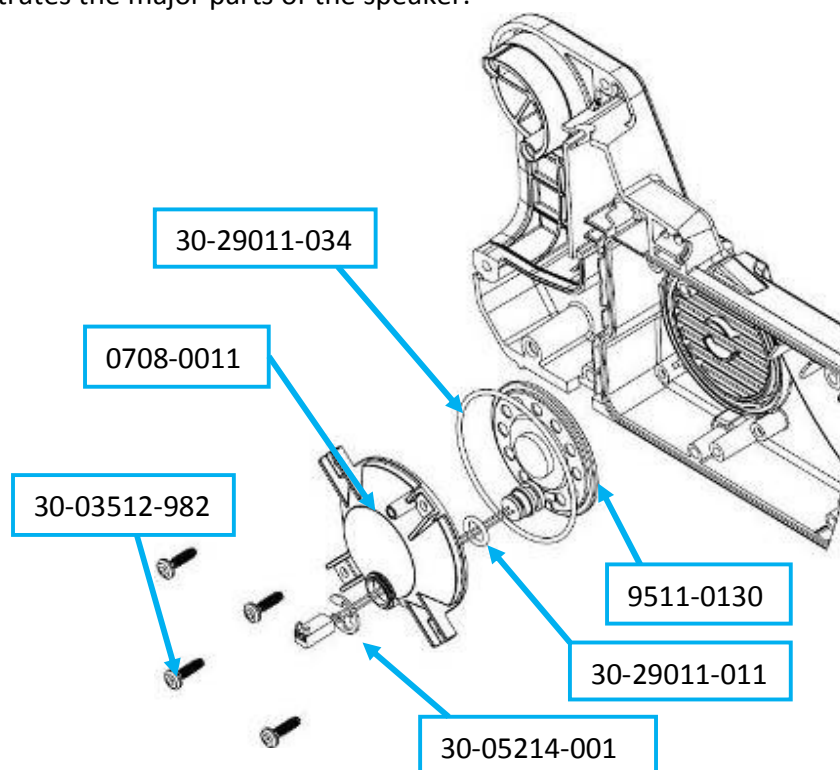

Figure 92: Speaker Kit

1	3004-0057	Speaker Kit , contains all items in this table
2	0708-0011	Enclosure Speaker
3	30-05214-001	Circlip External 7mm
4	30-29011-011A	O-Ring BS011 Silicone
5	30-39300-011	Tape Double Sided PVC 10x10x4.8mm
6	9511-0130	Wiring Loom and Speaker
7	30-29011-034	O-Ring BS034 Speaker
8	30-03512-982	Screw 3.5x12skt

Table 8: Speaker Parts

b. Open the detector body as described in Section [3.1 - Opening the Detector Body](#). Once completed:

- Remove the four screws (12mm) from the speaker assembly in the right side of the detector body.

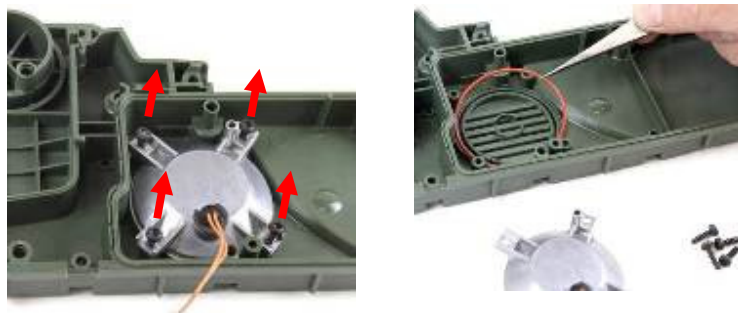

Figure 93: Replacing Speaker Assembly

- Check speaker assembly is in good working order and the speaker cable is correctly sealed into the speaker assembly and the E-Clip is fitted.
 - Check the speaker O-ring is clean, lightly greased and correctly positioned in its channel in the detector body.
 - Position the speaker assembly and fit the four screws (12mm).
- c. Assemble the detector as described in Section [3.2 - Closing the Detector Body](#).

3.9.3 Wiring Loom Earset Replacement

a. The wiring loom earset is a line replaceable unit and is available as a service kit, 3004-0058 Wiring Loom Earset Kit which includes associated parts. Figure 94 illustrates the major parts of the wiring loom earset.

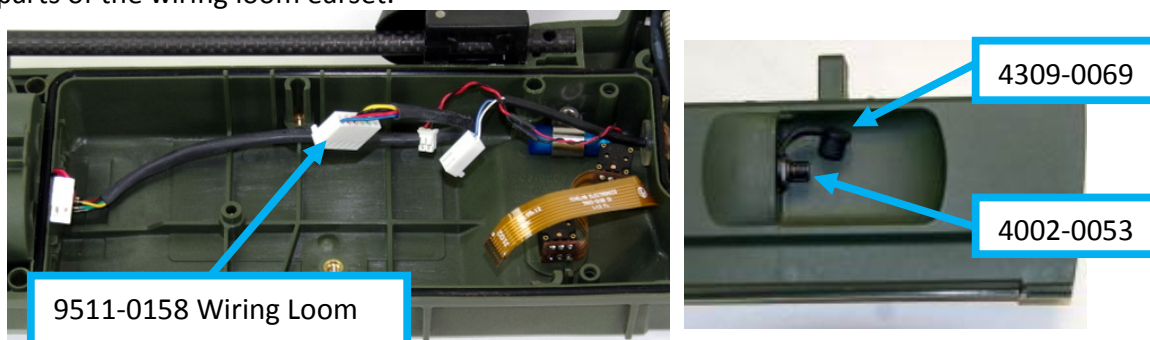

Figure 94: Wiring Loom Earset Kit

1	3004-0058	Wiring Loom Earset Kit , includes all items in this table
2	9511-0158	Wiring Loom Earset
3	4309-0069	Dust Cap Earset Connector
4	4002-0053	Nut Earset Connector

Table 9: Wiring Loom Earset

b. Open the detector body and remove the main PCB as described in Section [3.1 - Opening the Detector Body](#) and [3.3.1 - Removing the Main PCB](#). Once completed:

- Disconnect the wiring loom earset from the main PCB.
 - Unscrew the 13mm nut from the earset connector and remove the nut and the connector dust cover.
- c. The wiring loom earset can now be removed and replaced as required. The wiring loom earset is fitted to the detector following the reverse order of the removal.

3.9.4 Wiring Loom Handle Socket Replacement

- a. The wiring loom handle socket is a line replaceable unit and is available as a service kit, 3004-0056 Wiring loom Handle Socket Kit, which includes associated parts. Figure 95 illustrates the major parts of wiring loom handle Socket.

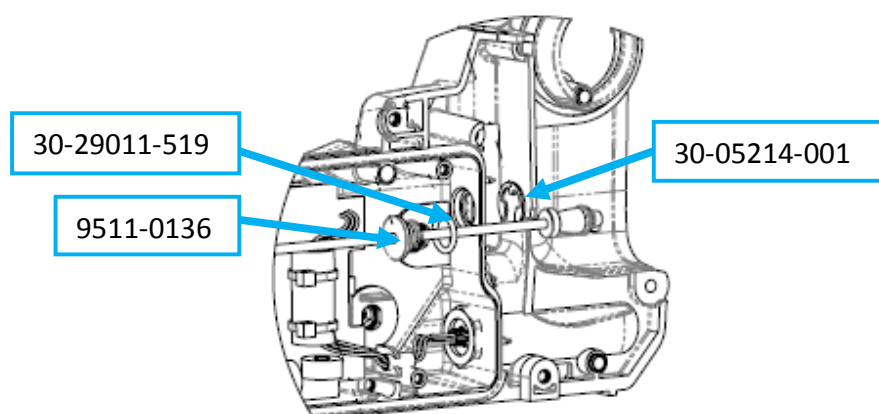

Figure 95: Wiring Loom Handle Socket Kit

1	3004-0056	Wiring Loom Handle Socket Kit , contains all items in this table
2	9511-0136	Wiring Loom Handle Socket
3	30-29011-519	O-Ring BS012
4	30-05214-001	Circlip External 7mm

Table 10: Wiring Loom Handle Socket Kit

- b. Open the detector body as described in Section [3.1 - Opening the Detector Body](#). Once completed:
- Disconnect the wiring loom handle socket from the handle wiring loom.
 - Disconnect the wiring loom handle socket from the main PCB.
 - Remove the E-Clip from the wiring loom handle socket at the entry point to the detector body.

- c. The wiring loom handle socket can now be removed and replaced. To fit the wiring loom handle socket follow the removal instruction above in reverse order. Then assemble the detector as described in Section [3.2 - Closing the Detector Body](#).

3.9.5 Detector Body Parts

This section of the manual describes the parts of the F3Ci detector in the body of the detector that are not covered by the range of line replaceable units, figures 96 to 99 illustrate these parts



Figure 96: Detector left side

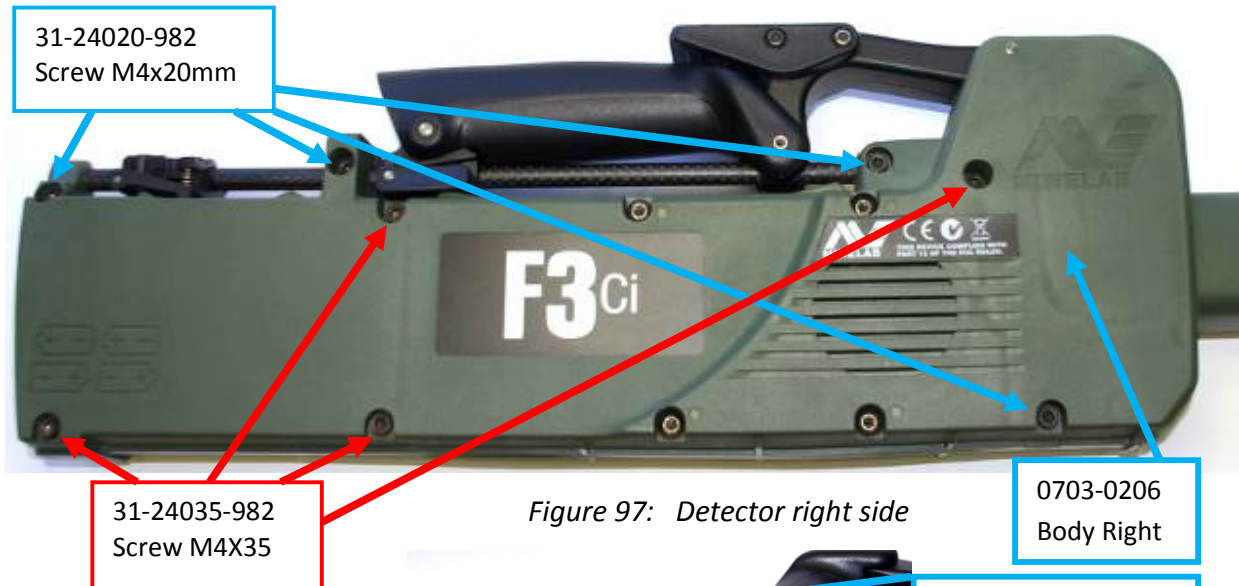

Figure 97: Detector right side

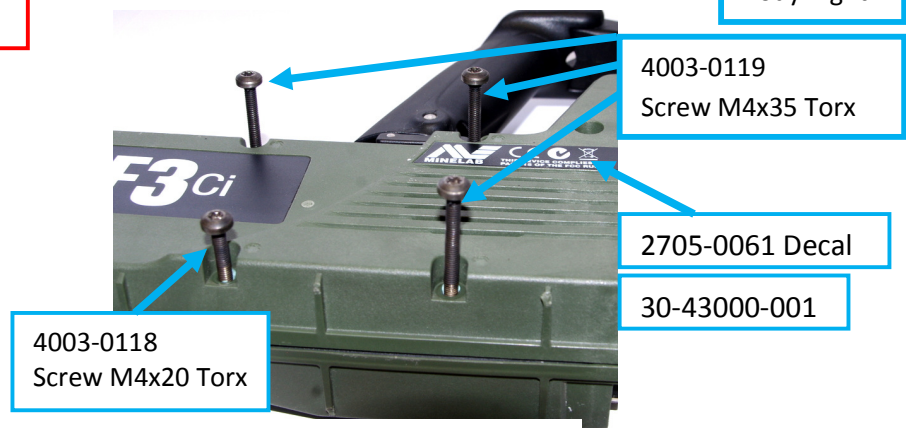

Figure 98: Detector right side

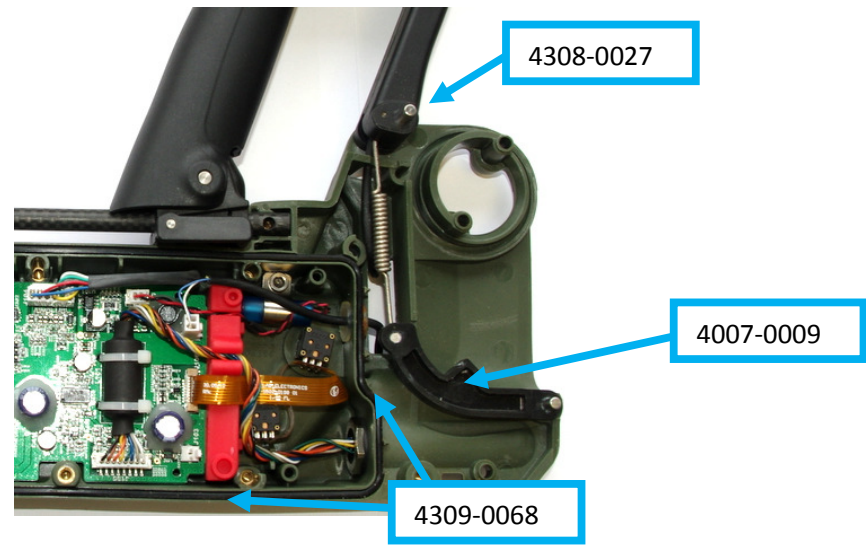

Figure 99: Detector body parts

1	0703-0203	Hinge Cover
2	31-24045-982	Screw M4x45skt head
3	0703-0205	Chassis Left (switches side)
4	0703-0206	Chassis Right (speaker side)
5	0304-0027	Rod Handle Slide
6	4309-0068	Seal Detector Body
7	4007-0009	Latch Hinge
8	4308-0027	Pin Handle Pivot
9	2703-0040	Decal Switches
10	2705-0061	Decal Compliance
11	2705-0025	Decal Serial Number
12	30-43000-001	Vent Gore
13	31-24020-982	Screw M4x20 skt head
14	31-24035-982	Screw M4x35 skt head
15	4003-0118	Screw M4x20 Torx with seal
16	4003-0119	Screw M4x35 Torx with seal

Table 11: Detector body parts

4 Fault Finding Procedures

4.1 Introduction

- a. A functional test failure can generally be repaired by replacing one or more of the line replaceable units.
- b. The F3Ci is designed so that line replaceable units can be exchanged between detectors without the need to calibrate. This means that where spare parts are not available and more than one detector is faulty, then parts from one detector can be used to make another serviceable. For example, if detector # 1 has an unserviceable coil and detector # 2 has an unserviceable battery compartment, then the coil from detector # 2 can replace the coil on detector # 1 thereby producing a serviceable detector.

4.2 Trouble Shooting Table

- a. The following table identifies a number of faults and provides recommended solutions. The suggested solutions should be investigated in the order they are listed.

Problem	Recommended Solutions
Detector will not switch on	<ul style="list-style-type: none"> ● check batteries are installed correctly ● replace batteries with fresh batteries ● replace battery compartment ● replace main PCB
Detector will not switch off	<ul style="list-style-type: none"> ● remove batteries ● replace Main PCB
After switching on the detector makes no sound from speaker	<ul style="list-style-type: none"> ● check for tone using the earset, turn LEDs on ● if there is tone through earset – replace the speaker ● if there is no tone through earset – replace main PCB
Ground Balance does not work	<ul style="list-style-type: none"> ● replace handle ● replace coil ● replace main PCB
Noise Cancel does not work (no Noise Cancel tones emitted)	<p>Note: Noise Cancel may not completely remove the effects of interference if the source is powerful or in close proximity</p> <ul style="list-style-type: none"> ● repeat Noise Cancel ● replace handle ● replace main PCB
LEDs do not illuminate	<ul style="list-style-type: none"> ● remove earset ● Turn on the LEDs ● replace handle ● replace main PCB
Cannot hear the Test Piece	<ul style="list-style-type: none"> ● fit and use an earset ● set sensitivity switch to default 4 ● conduct Noise Cancel ● ensure coil plug is firmly connected ● replace main PCB ● replace coil
Start Up tones keep repeating	<ul style="list-style-type: none"> ● insert new batteries ● replace battery compartment ● replace main PCB

Earset does not work	<ul style="list-style-type: none"> ● replace earset ● replace wiring loom earset
Hinge will not lock shaft extended	<ul style="list-style-type: none"> ● push the handle up ● reconnect the spring latch hinge to the latch hinge
Armrest will not move	<ul style="list-style-type: none"> ● replace armrest with slide
Coil does not remain in place (floppy)	<ul style="list-style-type: none"> ● tighten adjustment screws ● replace coil pivot kit
Water found inside battery pack	<ul style="list-style-type: none"> ● clean battery lid and apply silicone grease to battery lid O-ring
Camlocks will not stop shafts from collapsing	<ul style="list-style-type: none"> ● replace camlock kit
Battery Lid will not close	<ul style="list-style-type: none"> ● remove and clean O-ring ● replace swollen batteries if applicable

Patents and Trademarks:

Patents and trademarks may apply to this product.

Patents: www.minelab.com/patents.

Disclaimer

As a world leader in metal sensing technology, Minelab strives to continually improve its product range. Minelab reserves the right to introduce changes to the design, technical features and accessories of this product.

Contact Details:

Minelab Electronics Pty Ltd

Tel: +61 (0)8 8238 0888

email: countermine@minelab.com.au

Minelab Americas Inc

Tel: +1 630 401 8150

email: countermine@minelab.com.au

Minelab International Ltd

Tel: +353 (0)21 423 2352

email: countermine@minelab.com.au

www.minelab.com

oOo